



ALARM LOCK

345 Bayview Avenue
Amityville, New York 11701

For Sales and Repairs 1-800-ALA-LOCK
For Technical Service 1-800-645-9440

Publicly traded on NASDAQ Symbol: NSSC

© ALARM LOCK 2007

DL-WINDOWS™

V3.5.6 and V3.6.0

USER'S GUIDE

OI237G 1/07



DK3000



PDK3000

Downloading Software for the Trilogy® Line of Standalone Access Control Systems



ETDL



PDL3500
PDL4500 - "RESIDENCY" LOCK



DL3500
DL4500 - "RESIDENCY LOCK"



PDL3000
PDL4100 - "PRIVACY" LOCK



DL3000
DL4100 - "PRIVACY LOCK"



AL-DTM
DATA TRANSFER
MODULE



AL-IR1
INFRARED PRINTER



AL-PRE PROX
CARD READER/
ENROLLER



PL3000

Table of Contents

DL-Windows Features.....	3
Supported Products.....	4
Product Communication Examples.....	5
Overview.....	6
Terminology.....	7
DL-Windows Buttons.....	9
DL-Windows Main Menu.....	10
Quick Start Checklist.....	11
DL-Windows Software Installation.....	12
Upgrading From a Previous Version of DL-Windows.....	13
DL-Windows Security Features.....	14
Create a New Account and Add Locks.....	15
Add Users with the Global Users Screen.....	16
Enroll ProxCards® with the AL-PRE.....	17
Creating Schedules and TimeZones.....	20
Send/Receive Information to/from the Lock.....	21
Sending Data directly to the Lock from the PC.....	22
Receiving Data from the Lock.....	23
Configure the AL-DTM.....	25
Send Data from DL-Windows to the AL-DTM.....	26
Send Data from the AL-DTM to the Lock.....	27
Receive Event Logs with the AL-DTM.....	28
"Global Users" Screen - Field and Button Definitions.....	29
"Set Administrative Users" Screen - Field Definitions.....	30
"Lock Data" Screen - Field Definitions.....	31
"Event Log Viewer" Screen - Field Definitions.....	32
"Programmable Features" Screen - Options tab.....	33
"Programmable Features" Screen - Customize DST.....	34
"Programmable Features" Screen - Relay Functions tab.....	35
"Programmable Features" Screen - Remote tab.....	36
"Programmable Features" Screen - 4000 Series tab.....	37
"Schedule-TimeZone" Screen - TimeZones Area.....	38
"Schedule-TimeZone" Screen - Schedule Entry Area.....	39
"Schedule View" Screen - Program Field Definitions.....	40
"Options" Screen - Program Field Definitions.....	41
Exporting and Importing Data.....	42
Transferring Account Files Between PC's.....	43
"DTM 3 Support" Screen - Program Field Definitions.....	44
AL-DTM Specifications.....	45
Compact and Repair the Database.....	46
Foreign Language Support.....	47
Advanced Programming.....	48
Advanced Programming--Group 1 Activated Events.....	49
 Appendix A	
AL-DTM Communications with the PL3000 locks.....	51
 Appendix B	
"Programmable Features" Screen (PL Series) - Options tab (Version 3.5.6).....	53
 Glossary.....	54
Warranty.....	56

DL-Windows Features

Basic Functions

When installed on an IBM compatible desktop or notebook computer, DL-Windows can provide the following functions:

- Create a new Lock Program
- Edit an existing Lock Program
- Send a Lock Program to a lock
- Receive a Lock Program from a lock
- Retrieve an Audit Trail (Event Log records) from a lock
- Configure an AL-DTM to transfer data to multiple locks
- Read ProxCards[®] using the ProxCards[®] Reader (AL-PRE)

Features

- Fully Integrated Help File Systems and Online Manual
- Supports up to a 2000 User Database
- Allows Viewing of 40,000 Event Audit Logs
- Account and Database Utilities
 - Compact and Repair Database
 - Import / Export
 - Rename Accounts
 - Search Feature-to Quickly and Easily Find Users

New Features for Version 3.5.X

(**Note:** The "X" denotes any release of version 3.5).

- **LockID** (see page 21). "Door Numbers" are now referred to as "LockID's", with Accounts in DL-Windows v3.5.X now able to accommodate up to a maximum of 2000 locks. Each **LockID** is unique to each lock, ensuring the validity of data and that each lock is matched to the correct data when programmed.
- **Global Administrative Users** (see page 30). A new "Set Administrative Users"

button simplifies the organization of those special Users possessing a greater range of programming abilities. All Users designated as "Administrative Users" will be identical for all locks within the Account.

- **Individual Group Assignments** (see page 16) Group Support: A single user can be assigned to different Groups in different locks within an Account
- **Creating and Cloning Multiple Locks** (see page 15). Allows you to save time when creating a new lock. Cloning duplicates all schedules and Users programmed from an existing lock. You can clone up to 2000 locks of the same lock type. **Note:** All models can be cloned into all other models, with the following exceptions: DL2800 and DL3000 locks can only clone each other, and the DL3500 can only clone itself.

New Features for Version 3.6.0

- **Daylight Saving Time** (see page 33-34). The manner in which Daylight Saving Time (DST) is observed varies with location, therefore the DST adjustment is fully flexible to accommodate these regional differences.

Supported Products



DK3000 / PDK3000

Relay-only locking device, 2000 Users, 500 schedules, 40,000 Audit Trail events. The **PDK3000** adds Prox capability.



DL3000 / DL2800

300 User Codes, 150 Schedules, 1600 Audit Trail Events. Refer to OI224 for more information on **DL3000** features. DL-Windows also supports the similar **DL2800**, which supports 200 Users.



DL3500 / ETDL / ETPDL

DL3500: 300 User Codes, 500 Schedules, 40,000 Audit Trail events. Refer to W11005 for more information on DL3500 features. **ETDL**: 2000 User Codes, 500 Schedules, 40,000 Audit Trail Events. **ETPDL** adds Prox capability



PDL3000 / PDL3500 / PDL3300

2000 User Codes/ProxCards® or ProxKey® keyfobs, 500 Schedules, 40,000 Audit Trail Events. Refer to W11021 for more information on features. DL-Windows also supports the similar **PDL3500** mortise lock and **PDL3300** Door Ajar lock with Prox capability.



DL / PDL4100 ("Privacy")

DL / PDL4500 ("Residency")

The "Residency" feature is specially designed to prevent unintentional lock-out, and the "Privacy" feature is designed to deny access to other users after an individual enters. Refer to W11194 and W11195 for more information.



ProxCard® / ProxKey® Keyfob

Compatible with most HID ProxCards® and ProxKey® keyfobs (26-37 bits).

Note: ProxCard® and ProxKey® are trademarks of the HID® Corporation.



Data Transfer Module (AL-DTM)

The **AL-DTM** allows the transfer of Lock Programs and other data between DL-Windows and locks. See page 45 for detailed **AL-DTM** specifications and feature descriptions.

Note: For DL-Windows versions 3.5 or higher, the AL-DTM-III must be used, but will be referred to as simply the "AL-DTM" in this manual.



Prox Card Reader/Enroller (AL-PRE)

An **AL-PRE** is used to quickly enroll multiple ProxCards® and ProxKey® keyfobs into DL-Windows. Use the supplied 9-pin DB9 to DB9 serial cable to connect the AL-PRE to your computer's serial COM port. Compatible with most HID ProxCards® and ProxKey® keyfobs (37 bits or less). For PDL series locks only.



Infrared Printer (AL-IR1)

An **AL-IR1** printer is used to print Audit Trails and User Code lists (where used) without the need for a PC. Its infrared reader means no cable connection to the lock is needed.

All supported locks:

- DL1200
- DL1300
- DL2800
- DL3000
- DL3200
- DL3500
- DL4100
- DL4500
- DK3000
- ETDL
- PL3000
- PDL1300
- PDL3000
- PDL3300
- PDL3500
- PDL4100
- PDL4500
- PDK3000
- ETPDL

AL-PCI2 Cable

An ALARM LOCK **AL-PCI2** cable is required to communicate between your computer's RS-232 serial communications port (COM 1-4) and the **AL-DTM** or lock. One end of the **AL-PCI2** cable is designed to be plugged into a DB-9 male 9-pin serial COM port. If your computer has a 25-pin COM port only, a 25-pin to 9-pin adapter must be used. The other end of the **AL-PCI2** cable features a 2-pin banana plug connector which is polarity sensitive--the TAB (marked "GND") side must be plugged into the lock's **black** (left) terminal.



Double-ended Mini Banana Plug Connector (supplied)

After you create the program in DL-Windows and transfer the program from your computer to an **AL-DTM**, transfer the program from the **AL-DTM** to the lock(s) via a double-ended mini banana plug. You can also use this cable to transfer the Lock Program from your lock to an AL-PRE.

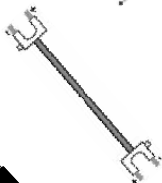

DB9 to DB9 Serial Cable (supplied)

Enroll ProxCards quickly into DL-Windows, then transfer this new ProxCard® data from the computer to the **AL-PRE** via this 9-pin DB9 to DB9 serial cable. Once the data is in the **AL-PRE**, you can transfer the data to the lock via the double-ended mini banana plug (see above), thus avoiding the need to use an **AL-PCI2** cable for this process.



Product Communication Examples





IBM COMPATIBLE
LAPTOP OR DESKTOP PC

AL-PCI2 CABLE
CONNECT TO SERIAL PORT
(COM 1-4)



NOTE: OBSERVE TAB DIRECTION WHEN
INSERTING CABLE INTO LOCK



PDL3000 LOCK

If your computer does not have a serial COM port (DB-9 male) available, you can plug your AL-PCI2 cable into a special **USB to RS-232** cable. Order part **PCI-USB** for the **USB to RS-232** cable only, or **ALPCI2-U** for both the **USB to RS-232** cable and an **AL-PCI2** cable.



Scenario 1 Create the program in DL-Windows on your computer, then transfer the program from the computer directly to the lock via an AL-PCI2 cable. Enter the User 298 User Code to send or receive data to of from DL-Windows. When no COM port exists, use a **USB to RS-232** cable.



IBM COMPATIBLE
LAPTOP OR DESKTOP PC

AL-PCI2 CABLE
CONNECT TO SERIAL PORT
(COM 1-4)



NOTE: OBSERVE TAB DIRECTION WHEN
INSERTING CABLE INTO LOCK



AL-DTM DATA
TRANSFER
MODULE

DOUBLE-ENDED MINI BANANA
PLUG CONNECTOR

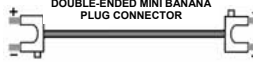

NOTE: OBSERVE TAB DIRECTION
WHEN INSERTING CABLE INTO AL-
DTM AND LOCK



PDL3000 LOCK

Scenario 2 Create the program in DL-Windows and transfer the program from your computer to an AL-DTM (via an AL-PCI2 cable)... then transfer the program from the AL-DTM to the lock(s) (via a double-ended mini banana plug). The hand-held AL-DTM is useful because you do not have to transport (or find electricity for) your computer. Data can also flow in reverse, from the lock, through the AL-DTM, back to the computer for examination.



IBM COMPATIBLE
LAPTOP OR DESKTOP PC

CONNECT DB9 CABLE
TO COMPUTER SERIAL
PORT (COM 1-4)

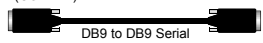

DB9 to DB9 Serial
Cable (supplied)



AL-PRE PROXCARD READER/
ENROLLER

DOUBLE-ENDED MINI BANANA
PLUG CONNECTOR



NOTE: OBSERVE TAB DIRECTION
WHEN INSERTING CABLE INTO AL-
PRE AND LOCK



PDL3000 LOCK

Scenario 3 Enroll ProxCards® quickly into DL-Windows, then transfer this new ProxCards® data from the computer through the AL-PRE to the lock (thus avoiding the need to use an AL-PCI2 cable). For PDL series locks only.



AL-IR1
INFRARED PRINTER



PDL3000 LOCK

Scenario 4 Use the AL-IR1 Infrared printer to print your lock's audit trail (event log), User Code list, clock settings and software version. No cable required.

NOTE:

The AL-PCI2 cable is designed to be used on a 9 pin serial COM port. If your computer has a 25 pin COM port, a 25 pin to 9 pin adapter must be used.
Warning: Polarity **MUST** be observed when connecting cables to the lock. The tab (-) must plug into the negative (black) hole.

Overview

Why Use Software Inside a Lock?

With ordinary door locks, the need to make physical copies of metal keys and distributing them can be a huge organizational and financial task – and what will you do if someone causes a security breach by losing their key? The answer lies in the advantage of software.

Software (also called *firmware*) is not "hard" or "fixed" like hardware is. Software is flexible and changeable to your needs. Software exists inside your Alarm Lock™ series lock, and can be programmed (and re-programmed again and again) to suit your changing requirements. No more metal keys to distribute...instead, distribute *User Codes* – and delete them from the software when needed. (A *User Code* is the software equivalent of a metal key—it is a series of numbers the User presses into the lock keypad keys to unlock the lock). (**Note:** The PL3000 does not have a keypad—see WI1280).

Preparing to Program your Lock

There are two ways to make changes to the software inside your lock—either by using the lock keypad or by using DL-Windows. Although using DL-Windows makes programming faster and easier, we recommend you familiarize yourself with the general concepts of keypad programming as well. The first step to programming your lock *without* DL-Windows requires that you enter something called "Program Mode".

What is Program Mode?

The software inside the lock has only two "modes"—*Normal Mode* and *Program Mode*. When you want to make changes to the lock program, you enter *Program Mode*. When you finish programming and wish to put the lock into use, you *exit Program Mode* to enter *Normal Mode*.

Use the keypad to enter Program Mode by pressing the *Master Code* of the lock that was set at the factory (see the *Programming Instructions* of the individual lock for more information). The Master Code is like a secret password that allows you to enter Program Mode. But since all locks are identical and leave the factory with the same Master Code, the factory Master Code is not very secret and should be changed to your own personal Master Code. This way, only YOU can enter Program Mode and make changes to the lock programming.

With most locks, changes to the lock are organized by their Function Number. Want to change the date inside the lock? Use Function Number 38. Want to add a User Code? Use Function Number 2.

With DL-Windows, you first use the various DL-Windows computer screens to make the programming selections, then later you send the programming selections from your computer to the lock's memory. You do this by clicking the **Comm** button in DL-Windows and selecting *Send to Lock* (see image at right). You can also use DL-Windows to *receive* programming from a lock, allowing you to observe the lock programming inside DL-Windows. Because your lock can be programmed using DL-Windows, and then using the keypad, DL-Windows will detect changes made by the keypad, and will alert you to these discrepancies in a screen named **Lock Differences**. See page 23 for more information.



The Global Users Screen

Perhaps the most significant part of DL-Windows is the **Global Users** screen and the concept of an "Account". An Account can be thought of as simply a building in which Alarm Lock locks are installed. If there are 55 locks in this building, and one person needs access to all of those locked doors, it would be convenient to assign that person *one* User Code to remember, and to enter their name in the computer only *once*—rather than having to enter their name 55 times. The Global Users screen was developed for this very reason—to support the concept of an Account, allowing a User Name to be entered only once, and to allow you—the person in charge of the locks—to sit back and assign this User to all locks in an Account with just a few clicks of the computer mouse.

Turn the page and learn the special terminology used with your lock, then use the Quick Start checklist on page 11 to help you get started.

DL-Windows System Requirements

This application has been tested and approved for an IBM-compatible P4 1.6 GHz computer with 256MB RAM and a minimum of 100MB of hard drive space running Microsoft Windows 98, 2000 or XP with one unused RS-232 Serial Communications port (COM 1-4) required. If a COM port is unavailable, please contact customer support for one of our USB adapters (**PCI-USB** or **ALPCI2-U**). Depending on your system demands, a slower PC may function properly but with significant user interface problems, including long intervals for the system to respond.

Global Users Screen

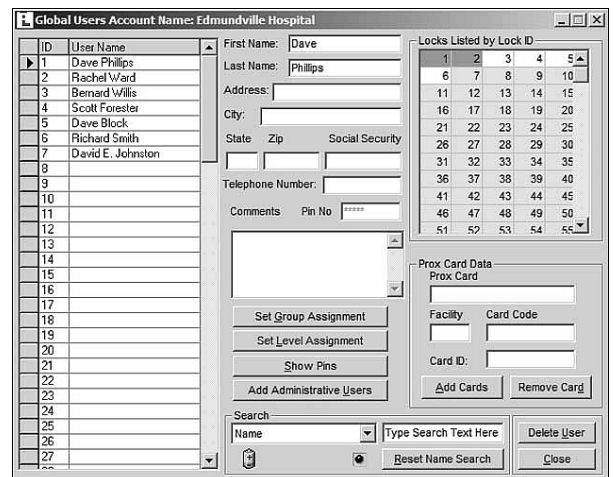

Terminology

DL-Windows

DL-Windows is a computer program that allows you to program your ALARM LOCK T3 Security Lock. You do not need DL-Windows to program your lock, but it makes programming much faster and easier. With DL-Windows, you can quickly create Lock Programs (programs that make the lock perform its many functions) add multiple Users (who have access), add ProxCards® and ProxKey® keyfobs, retrieve event logs, and create Schedules. The benefit of DL-Windows is that it allows you to set up all lock programming in advance (on your computer), and then send the information to the locks at your convenience.

This Users Guide to DL-Windows will guide you through all aspects of the lock—from the software installation procedure through the creation of a Lock Program, from the transfer of lock programming to the viewing of lock event logs.

ALARM LOCK makes a variety of computer interfaced microprocessor-based programmable keypad-entry and ProxCards® security locks: DL3000, DL3500 and PDL Series Access Control Locks. DL Windows works with them all.

Users

A User is a person who is authorized to simply use or make certain programming changes to the lock. This User can be anyone—from a one-time visitor (who will almost certainly have no authority to make changes) to the owner of the building in which the lock is installed (who will probably wish to have total authority to make changes). Most PDL Series locks can hold up to 2000 Users in its programming memory, and each User possesses a pre-defined level of authority—a **Programming Level**—as to their ability to use or make changes to the lock.

Lock Program

A Lock Program contains the instructions that a lock uses to perform its various functions. You can use DL-Windows to create a Lock Program on your computer, and then transfer and store the Program in the circuitry contained inside the lock itself. The Lock Program is essentially a computer database file that maintains feature settings, schedules, audit trails, etc. Using DL Windows, Lock Programs can be created with default information, edited on your PC, and then sent to (and even received from) locks.

The **Lock Program** consists of 4 areas: **User Codes**, **Features**, **Time Zones**, and **Schedules**, all defined below:

User Codes

Also called *User Access Codes* or *PIN No. Codes*, User Codes are numbers the User enters into the lock keypad to unlock the lock. Using DL-Windows, Users are matched with their own individual User Codes. The User Codes are part of the Lock Program, and the Lock Program is stored in the lock circuitry awaiting the Users to key in their User Codes.

Features

Your lock is designed to support several options and functions. Using the **Programmable Features** window, you can select the features you wish to activate, such as if the lock will automatically adjust for Daylight Saving Time in the spring and autumn, or if the lock sounder should be disabled or enabled.

TimeZones

Events (recorded lock activities) can be programmed to occur at certain times. It is these times (for example, "every Tuesday at 5PM") that are referred to as *TimeZones*. You use the **Schedule-**

TimeZone screen to create these TimeZones, and once created, you can link events to these TimeZones. **Note:** The **Schedule-TimeZone** screen is "Global"—when a new TimeZone is created, it can be used for all locks in an Account. For more information, see page 20.

Schedules

Your lock can be programmed to maintain a schedule in which certain events can occur automatically. For example, you can program the lock to allow Groups of Users (with their User Codes) access ONLY during specific business hours. With another example, you can program another lock to UNLOCK at 9am, LOCK at noon for lunch, UNLOCK at 1pm, and LOCK again at 5pm—every weekday. As you can see, many different combinations of Schedules can be created to suit the needs of the Users. First you create *TimeZones* (see above) with the **Schedule-TimeZone** screen. Next you create events and link them to your TimeZones (also with the **Schedule-TimeZone** screen). When finished, you can view your schedule in the **Schedule View** screen.

Programming Levels

The Programming Level defines the range of programming tasks a User is allowed to perform. For most locks, the higher the Level, the more programming tasks the User is allowed (with the Master allowing ALL tasks for all locks).

Note: For the DL2800/DL3000 series locks, the Programming Levels are slightly different. See "Set Level Assignment" explanation on page 30 and also the DL2800/DL3000 programming manuals for more information.

Note: Since the Programming Level is closely associated with the type of User and their abilities, a User who holds a certain Programming Level is sometimes referred to by their "User Type".

For example, some locks can hold up to 2000 Users in its programming memory, and each User is associated with a User Number (see definition of "User Number" on the next page) and therefore a specific Programming Level, as shown in the following list of "Administrative Users":

Master: Always associated with User Number 1. Is always enabled and can program all functions. (Abbreviated as Programming Level = M).

Installer: Always associated with User Numbers 2 and 3. Can program all functions except changing the Master Code. (Abbreviated as Programming Level = 4).

Manager: Always associated with User Numbers 4, 5, and 6. Can program all functions except functions relating to lock configuration. (Abbreviated as Programming Level = 3).

Supervisor: Always associated with User Numbers 7, 8 and 9. Can only program functions relating to day to day operation. (Abbreviated as Programming Level = 2).

Print Only Users: Always associated with User Numbers 10 & 11. Restricted to print event logs only. No other programming ability allowed. (Abbreviated as Programming Level = 1).

Basic Users: Always associated with User Number 12 and higher (except 297-300). No programming ability allowed.

Programming Levels are hierarchical—higher levels are allowed to do anything the levels below them can do. For example, if you are a *Manager*, you are allowed to do anything that *Supervisors*, *Print-Only Users* and *Basic Users* can do in addition to those tasks allowed for Managers (Level 3). (Not applicable to the DL2800/DL3000).

(continued)

Minimum Required Program Level

This Programming Level abbreviation is the *minimum* programming level required to access the particular Function. (The higher the level number, the more programming tasks the User is allowed, with Master allowing all tasks).

In this manual, Programming Levels are abbreviated as follows: **M** = Master, **4** = Installer, **3** = Manager, **2** = Supervisor, **1** = Print Only Users

User Numbers

(*User Number = Location Number = User Location = Slot in Lock*)
User Numbers are used and are significant within each individual lock only. The User Number determines the Programming Level for each User. For example, many locks can hold up to 2000 Users in its programming memory. This memory can be thought of as simply a numbered list from 1 through 2000. Each entry in the list is represented by a User Number. Therefore, *where* a User is located in this list—their *User Location*—is a commonly used description of their User Number. Because of their similarities, a *User Number*, *User Location* and *Location Number* can be used interchangeably. In some DL-Windows screens, the word "Slot" is also used.

Since User Numbers are fixed, knowing a User Number will specify the associated Programming Level, and will in turn indicate a User's programming abilities. For example, User Number 1 is always the Master, who can perform all programming tasks.

Programming Levels are hierarchical—higher levels are allowed to do anything the levels below them can do. For example, if you are User 2, you are allowed to do anything that Users 3 through 2000 can do. Some DL series locks can hold up to 300 Users in its memory, however, the definition of a User Number is the same for these locks as well. (Not applicable to the DL2800/DL3000).

Groups

With many lock applications, it is convenient for large numbers of similar Users to be grouped together. Placing Users into Groups (by assigning them specific User Numbers) allows large numbers of Users to be controlled all at once rather than individually—saving time and effort. Groups are controlled via schedules, and a typical example involves enabling or disabling a Group at a certain time. For example, if you wish to add a User to Group 1, assign this User a User Number between 51 and 100. Default Group associations (see the lock programming instructions for details) can be changed if needed to allow Groups larger than the default number. In addition, a single User can be assigned to different Groups in different locks within an Account. See page 16 for more information.

Users 297-300

Many locks have Users assigned to User Numbers 297, 298, 299 and 300. These User Numbers have special abilities, as follows:

User 297: Quick Enable User 300

User 297 possesses the unique ability to enable the User Code associated with User 300. User 297 does this by first entering their own *User 297 User Code* into the lock keypad. When User 300 subsequently enters their *User 300 User Code*, the lock allows access (for one time) and then the *User 300 User Code* becomes disabled.

For example, you wish to allow one-time access to a temporary worker. Simply enter the *User 297 User Code* into the lock keypad. Later, when the temporary worker enters the *User 300 User Code* into the lock keypad, the *User 300 User Code* allows

access (for one time only) and then becomes disabled. Later, if you wish to grant the temporary worker re-access, simply re-enter the *User 297 User Code* and the *User 300 User Code* will be re-enabled (again for one time only). **Note:** User 297 is not used with the DL2800/DL3000 locks, but Function 9 can be used with the DL2800/DL3000 locks as an alternative.

User 298: Quick PC Access Code

Entering the User Code for User 298 enables that User to send data to or from the lock. Therefore, User 298 can activate what is the equivalent of Function 58 in Program Mode (see the lock programming instructions for details), without the need to enter Program Mode nor the need to know the Master Code of the lock. An AL-PCI2 cable with a PC is required. **NOTE:** The User Code for User 298 is not an Access Code and is not used with the DL2800/DL3000 locks.

User 299: AL-DTM Code

This is the only User Code that will initiate data transfer with the AL-DTM—and without allowing the User to pass through the door (the User Code for User 299 is not an Access Code). An AL-PCI2 cable and an AL-DTM (first programmed by the computer via the *DTM* screen in DL-Windows) is required.

User 300: Temporary Access

Temporary access User Code enabled by User 297. For example, User Code 300 is sometimes used for guard tour duties. See *User 297: Quick Enable User 300* above. **Note:** User 297 is not used with the DL2800/DL3000 locks, but Function 9 can be used with the DL2800/DL3000 locks as an alternative.

Accounts

Technically, an Account is a DL-Windows computer database file that allows you to organize and maintain multiple lock installations. But in practical terms, an Account is often named after the building or company location in which a lock or multiple locks have been installed. For example, the *Account Name* might be "Overbrook Hospital" and listed in that Account are the 4 locks you just installed on the 7th floor. In DL-Windows, Accounts can be created, edited, cloned and deleted. The benefit of an Account is that it allows you to add the name of a User ONCE and then assign that User to multiple locks within a building—rather than having to enter and re-enter the same User information again and again for each lock in your building. Enter the name of the User once in the Global Users screen, then sit back and assign that User to the locks you wish -- with just a click of the mouse.

Global ID Numbers

Note: The Global ID number can be hidden from view. See page 16 to show or hide the Global ID number.

A Global ID is used within the DL-Windows **Global Users** screen and is Account specific—it remains constant within Accounts only. A Global ID is not related to User Numbers nor Programming Levels. The Global Users screen simply lists all potential Users within an Account (which can contain up to 2000 locks).

DL-Windows keeps track of each "Global User" listed in the Global Users screen by use of the Global ID number, but its significance ends there—it acts as an internal designation only.

DL-Windows Buttons



The DL-Windows toolbar (above) allows you to open the screens and dialogs you will need to program your lock. It may be helpful to open each screen on your computer as you read. From left to right, they are as follows:



Open - View the Account Tree column, revealing a hierarchical tree listing of Accounts and locks within Accounts.



Log - Open the **Event Log Viewer** screen to examine a listing of all lock events --from a User entering their User Code to a change in a schedule.



Close - Close the Account Tree column allowing more room for other DL-Windows screens.



DTM - DTM Support screen allows you to configure and communicate with your Data Transfer Module.



Comm - Opens the **Receive from Lock** dialog or the **Send to Lock** dialog. Allows for direct communication between DL-Windows and the locks.



Global - The **Global Users** screen lists all potential Users in an Account. You can assign Users to locks, specify their User Location and add/remove ProxCards® (along with any other User information).



Lock - Opens the **Lock Data** screen, which allows you to "view the programming" inside the lock, such as the names of the Users, their User Numbers (and their associated Programming Levels) and their User Codes.



Opt - Opens the **Options** dialog, allowing you to determine various program alternatives within DL-Windows, specify StartUp screens and select the DL-Windows user interface language.



Sched - Opens the **Schedule-TimeZone** screen, allowing you to create automatic lock programs by choosing certain points in time (TimeZones) to which events are linked (Schedules). See **SchV** button, below.



Help - Opens the DL-Windows **On-line Help** file.



SchV - Opens the **Schedule View** screen, revealing a compiled view of all TimeZones and Schedules that were created using the **Schedule-TimeZone** screen .



Feat - Opens the **Programmable Features** dialog, which allows you to choose various Options within the DL-Windows software.

DL-Windows Main Menu

File Options Tools Window Help

Menu System and Shortcut keys

The sub-menus within the DL-Windows Main Menu bar can be activated by clicking the mouse or via shortcut keys. They are as follows:

File Menu (Alt + F)

Exit - Quits and closes the application.

Options Menu (Alt + O)

Show Options

Tools Menu (Alt + T)

Manage Users

Set Security Password

Edit Languages

Com Port Setup and Test

Import CSV File

Import CSV File From Excel

Import CSV File From DL-Windows

Export Active Account to CSV

Import a Single ADF Account File

Check for Ambush Code Conflict

Compact and Repair Database

Window Menu (Alt + W)

Cascade - (Can also press F5)

Lock Data

Schedules

Schedule View

Features

Event Log Viewer

DTM

Global Users

Help Menu (Alt + H)

Contents - (Can also press F1)

Index - (Can also press F2)

Find - (Can also press F3)

What's This Help

DTM3 Help Screen

DL3000 Lock

DL3500 Lock

PDL3000 Lock

Alarm Lock On The Web

Help on Help

About

Quick Start Checklist

You have installed the locks in the doors. Now you want use DL-Windows to program the locks. What are the main steps?

OPENING STEPS

- 1. **Install the DL-Windows software** into your computer (see page 12)
- 2. **Create a new Account and add locks** (see page 15)
- 3. **Add Users** (and other data) using Global Users screen (see page 16)
- 4. **Enroll ProxCards** (for "PDL" locks only) (see page 17)
- 5. **Add Schedules and TimeZones** (see page 20)
- 6. **Send Information to the lock** (see page 21)

ADVANCED PROCEDURES

- 7. **Receive Information from the lock** (see page 23)
- 8. **Using the AL-DTM** (see page 25)
- 9. **Database Maintenance** (see page 46)
- 10. **Foreign Language Support** (see page 47)
- 11. **Advanced Programming Concepts** (see pages 48-50)

DL-Windows Software Installation

Installing DL-Windows Software



Note: Uninstall any previous version of DL-Windows before Installing DL-Windows. Account data associated with previous installations will remain intact, with the exception of Prox devices (see warning below). Use the **Update Database** utility on databases created using prior versions of DL-Windows. Please read the readme.txt file for the latest information about DL-Windows. See page 6 for DL-Windows System Requirements.

1. Place DL-Windows CD into the CD-ROM drive. The DL-Windows *InstallShield Wizard* will automatically begin the installation process.
2. If the Wizard installation process does not automatically begin, click **Start, Run and** type the following: D:\Program \English\setup.exe, where **D** is the Drive Letter associated with the CD-ROM. For installations other than **English**, please read the Setup.txt file located on the installation CD.
3. The Installation program will prompt you regarding the ReadMe file, and the installation destination folder on your hard drive. When installation is complete, you will be asked to reboot your computer.

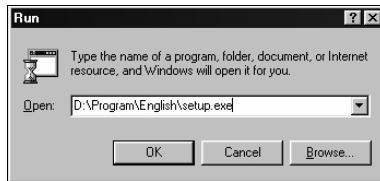

AL-PCI2 Setup

The comm port refers to a serial port located at the back of your computer that is used to communicate with the lock. Connect an **AL-PCI2** cable (or the supplied 9-pin DB9 to DB9 serial cable) to an unused comm port at the back of your computer. Leave the other end of either cable unconnected.

Select **Tools, Comm Port Setup and Test**. This **Comm Test** utility allows the DL-Windows software to detect which Com Port is connected to the cable. The first comm port that passes the DL-Windows automatic detection test will be selected. When finished, click **Exit**.

Note: If you are not using COM1, you must run this utility to identify the active comm port.

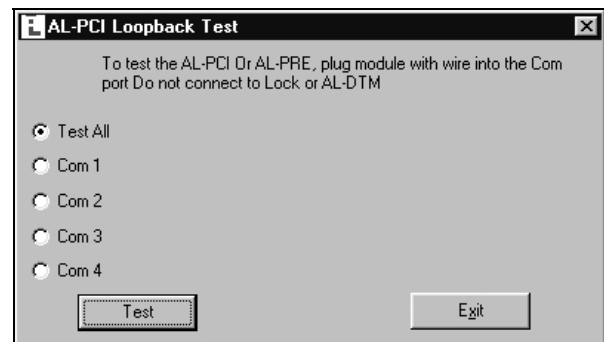

Starting DL-Windows

Click **Start**, select **Programs**, select the **DL-Windows** Program Group, then click on **DL-Windows 3.X.X**. After a few moments, the following screen will appear:

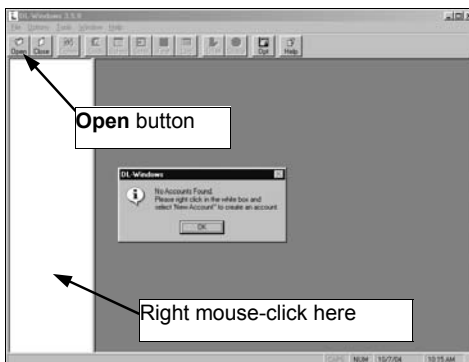

When opening DL-Windows for the first time (without any Accounts), the popup will appear, directing you to right-click in the white pane (the *Account Tree* area at the left) and select **New Account**. From this main screen you can create new Accounts, add locks to the Accounts, transfer data to and from locks, and perform all other needed tasks. Before starting, you will first need to select a Com port through which (via a wire cable) your computer and the locks will be connected.

Upgrading From a Previous Version of DL-Windows

NOTE: This section applies only to Accounts and locks created with previous versions of DL-Windows. For new Accounts, please ignore the following instructions.

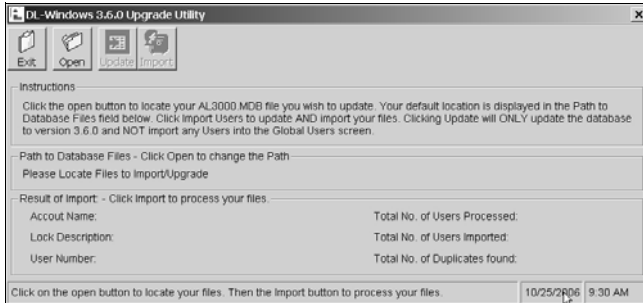

Open the Import Utility application by clicking **Start, Programs, DL-Windows, Import Utility**. The Import Utility application is independent of DL-Windows and allows the database files (Accounts) of previous versions of DL-Windows to be upgraded to the latest version of DL-Windows.

When running old Account database files in DL-Windows, you may encounter a pop-up message (shown below) requesting you run the Import Utility to update your Account files:

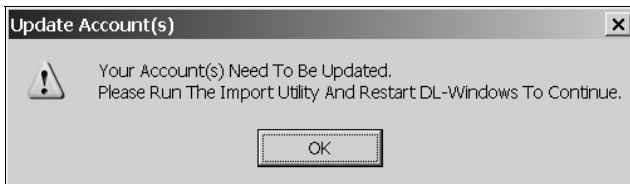

When first started, the Import Utility application defaults to the directory where your current working DL-Windows files are located (this directory is set from the DL-Windows Options screen). **Note:** If your computer stores your database files in more than one directory, you must run the Import Utility and update the files in each of these directories.

Click the **Open** button to select the directory the Import Utility will use.

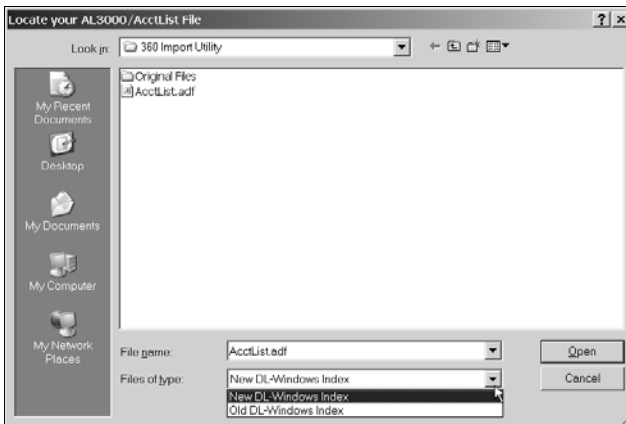

When selecting your database files, the **Files of type** pull-down menu lists two file types:

- **New DL-Windows Index** files
- **Old DL-Windows Index** files

The **Old** file type is listed as **AL3000.MDB** and the **New** file type is listed as **AcctList.adf**.

After selecting the file type, the Upgrade Utility determines which operation needs to be performed (either **Update** or **Import**) and enables the appropriate button to perform the needed operation. Regardless of the operation performed, the Upgrade Utility will create a new sub-directory named **Original Files** containing a backup of your original unchanged Account files. Should your upgrade operation not complete properly, the application will restore these original files back to the main directory.

Once **Update** or **Import** is selected, the Upgrade Utility will start to run and, depending on the file sizes and quantity, the process may take a while. Some older Accounts with many locks could take more than ten minutes to complete, while others may only take a few seconds.

When the Upgrade Utility is complete, a message box appears indicating the status of the upgrade.

DL-Windows Security Features

Security Features in DL-Windows

The DL-Windows software provides security and protection features to restrict unauthorized persons from accessing your DL-Windows program.

When starting DL-Windows, a user name and password are required to access the program. Creating user names requires a *User Type* be selected, (either *Operator* or *Administrator*). This *User Type* determines the range of tasks allowed within DL-Windows. Creating authorized users should be the first step in programming the DL-Windows software. **Note:** For *Operators*, all administrative functions are grayed-out within both the **Global Users** screen and the **Options** screen. In addition, the functions listed below are accessible by *Administrators* only:

Adding Users (for access to DL-Windows software)

1. Click **Tools, Manage Users** to open the **Manage Users** screen.
2. In the **Manage Users** screen, click **Action, Add User** (or press CTRL+A).
3. In the **Add User** dialog (shown below), type a **User Name** and a **Full Name** in the fields provided (the **User Name** will appear on the **Log-On** screen when starting DL-Windows).
4. Select the access level by checking either **Operator** or **Administrator** in the **User Type** area. Users can be created but disabled by simply un-checking **Enable User**.
5. Enter a password (at least 4 characters) in the **Password** field and re-type the password in the **Confirm** field to verify.
6. When finished, click **OK** to save, or click **Cancel** to discard your changes.

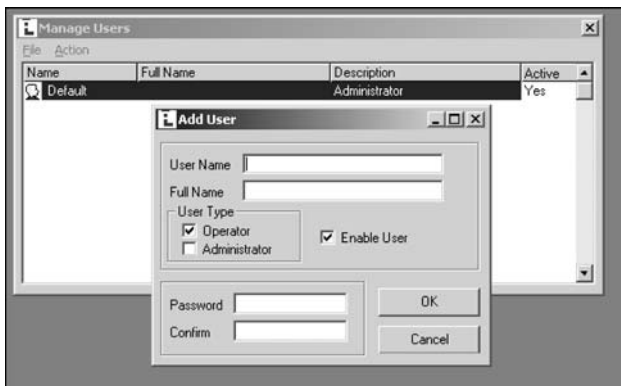

Editing and Deleting Users

To edit existing users:

1. Either click **Action, Edit User**, press CTRL+ E, or double-click the user to open the **Edit User** dialog.
2. All existing information can be edited, and when finished, click **OK** to save or click **Cancel** to discard your changes.

To delete an existing user:

1. Click to highlight the user in the **Manage Users** screen.
2. Click **Action, Delete User** or press CTRL+ D.
3. A confirmation popup will appear.
4. Click **Yes** to confirm the deletion, and click **No** to retain the user.

Change an Existing Password

1. Click to highlight the user in the **Manage Users** screen, then click **Action, Set Password** (or press CTRL+ P).
2. In the **Change Password** dialog, type the existing password in the **Old Password** field, type a new password in the **New Password** field and re-type the same new password in the **Confirm** field.
3. Press **Enter** on your keyboard to accept the changes.

Security Password

DL-Windows can utilize a *Security Password* to safeguard against an unscrupulous person with knowledge of your AL-DTM or PC download code. The *Security Password* prevents an unauthorized user from reprogramming your installed locks with their own copy of DL-Windows. Entering this password into DL-Windows prior to initial programming of your locks copies the password to a special area within the locks. *The password never needs to be entered again.* Subsequent communication between DL-Windows, the AL-DTM and your locks will automatically check for this password. If a different copy of DL-Windows is used to program your locks, the passwords will not match and no data transfer will take place. Once this *Security Password* is stored within your installed locks, the only way to change the *Security Password* is to erase all lock programming for each lock (re-loading the factory default program) and then re-program each lock with a new *Security Password*.

The *Security Password* ensures that only *your* copy of DL-Windows can communicate with *your* locks. The *Security Password* also makes certain that *your* copy of DL-Windows must be used to program the AL-DTM in order for it to exchange information with *your* locks.

If desired (but not recommended), the use of more than one copy of DL-Windows is possible--provided that the same password is entered in all copies of DL-Windows.

To program the Security Password:

1. Click **Tools, Set Security Password**.

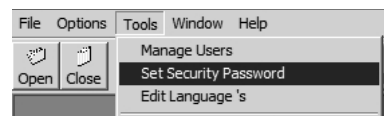

2. Before entering any information, be sure to write down the password to be used and save in a secure location. Once the Security Password is entered into the program, it cannot be retrieved.
3. In the **Set Security Password** dialog, type a unique 6-character password in the New Password field.

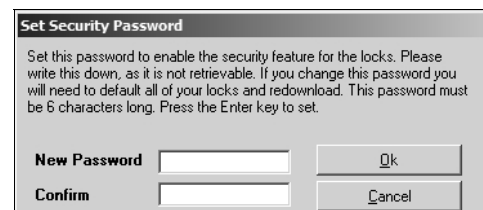

4. Re-type the same password in the **Confirm** field.
5. Click **OK** to save, or click **Cancel** to discard your changes.

Create a New Account and Add Locks

Create a New Account

When the DL-Windows screen first opens (below) click the **Open** button located on the toolbar (upper left).

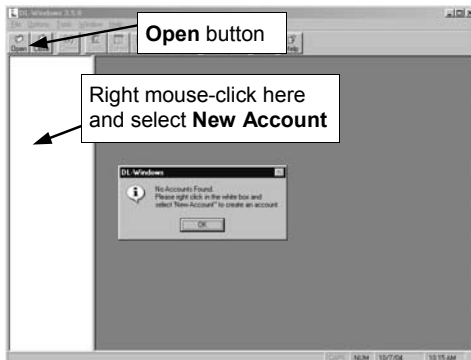

(For new installations, a popup appears with directions). First press **OK** to clear the popup, then (as directed by the popup) using your mouse, right-click anywhere in this white box (the Account Tree area at the left), and select **New Account**. The **New Account** dialog opens.

New Account Description

Enter the **New Account Description** in the field shown at right. The Account Description will typically be the name of the company or facility where a lock(s) will be installed. Existing Accounts from previous installations are also displayed. Click **OK**.



Delete an Account

If you wish to delete an Account, right mouse-click the name of the Account and select **Delete Account** from the menu. A warning popup will appear, and click **Yes** to confirm, and click **No** to cancel.

Add Locks to the Account

New Lock Description

After entering the new Account description, the **New Lock** dialog automatically appears (shown below). Type the description of the new lock, which will typically be the name of the door or department in the facility. Select the **Type of Lock** to be programmed from the drop-down list. When finished, click **OK**. **Note:** To add a new lock to an existing Account, first open any existing lock in the Account, then right-click in the white column and select **New Lock**. The **Number of Locks to Create?** field allows you to create multiple locks of the same lock type. You can also "clone" locks (see next section named "Right Click Menu"). **Note:** If you select a 4000 Series lock, a special **Mode of Operation Wizard** dialog appears (shown below) which allows you to select the type of lock programming for that lock's application. See page 37 for more information about the Privacy and Residency Features in the PDL4100/DL4100 and PDL4500/DL4500 series locks. Displayed below is a **New Lock** dialog used for adding new locks, and a **4500 Series Mode of Operation Wizard** dialog:



Press the **Global** button. The **Global Users** screen will appear (below). Programming of User Codes, Programmable Features and Schedules can now begin. **Note:** The screens that display on StartUp can be selected under **Options** (press the **Opt** button).



For **Global Users** screen field and button definitions, see page 29. For more information about Programming Levels and the lock default tables, see the individual lock programming instructions for details.

Right Click Menu

Select an Account, double-click a lock and right-click in the Account Tree area. The following menu appears:

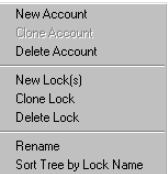

New Account and **New Lock** are described above. **Clone Account** allows you to save time when creating a new Account by duplicating all information in an existing Account, with the exception of the lock information. Therefore, after cloning an Account, new locks must be added, but all names, Prox Card and other data in the Global Users Screen will be duplicated. Select **Delete Account** when you wish to remove an Account from DL-Windows permanently. Press **Yes** in the warning dialog only after you verify the Account to be deleted.

Clone Lock allows you to save time when creating a new lock. Cloning duplicates in the new lock all schedules and Users programmed from an existing lock. When cloning, the **Clone Lock Data** screen appears (below), which is very similar to the **New Lock** screen shown previously. In the **Number of Locks to Create?** field, click the drop-down list to clone up to 2000 locks of the same lock type. **Note:** All models can be cloned into all other models, with the following exceptions: DL2800 and DL3000 locks can only clone each other, and the DL3500 can only clone itself.

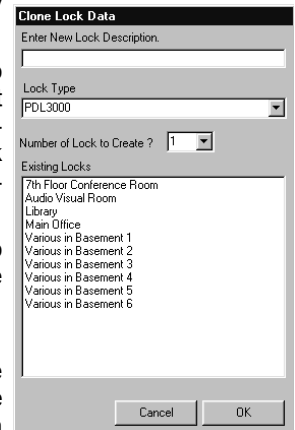

Select **Delete Lock** when you wish to remove the lock from the Account permanently. Press **Yes** in the warning dialog only after you verify the lock to be deleted. **Note:** You cannot delete the last lock of an Account.

Select **Rename** when you wish to rename the lock description of the selected lock.

Sort Tree by Lock Name/LockID

For each Account listed in the white pane (the **Account Tree** area at the left), the locks for each Account can be listed (top to bottom) either by the names of each lock (alphabetically) or by the LockID number (sequential order as added).

Add Users with the Global Users Screen

Overview

The **Global Users** screen is used to enter all User information. Users can be assigned to specific locks and assigned to Groups within locks. All Basic Users are entered here as well as the Level Assignment for DL3000/2800 locks. User lists can be imported from other DL-Windows Accounts or from comma delimited formatted lists. Administrative Users can be accessed through the **Global Users** screen via the **Add Administrative Users** button. Please see page 29 for the **Global Users** screen layout and field descriptions.

Add Users and User Codes

As displayed in the image below, type the first and last name of a User in the *User Information Fields*, and enter the remaining personal information as needed. Note that the names entered in the **First Name** and **Last Name** fields also appear in the **User Name** list.

Note: A specific PIN Number ("User Code") may be typed in the **Pin No.** field for each User --or-- random User Codes may be auto-generated for one or many Users by right-clicking in the **User Name** list.

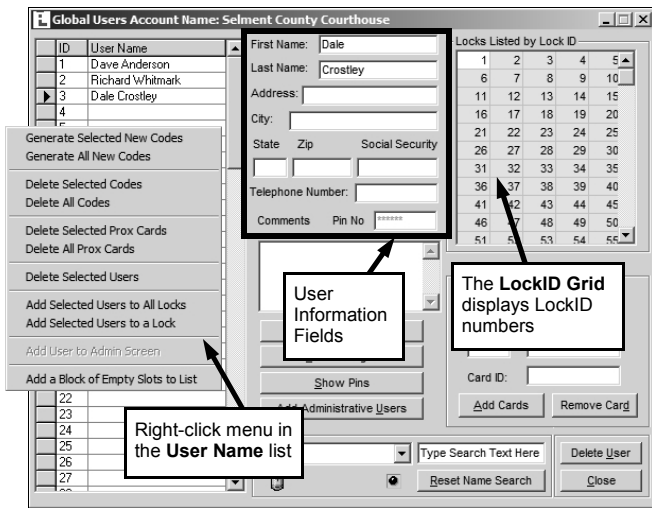

Select a Range of Users

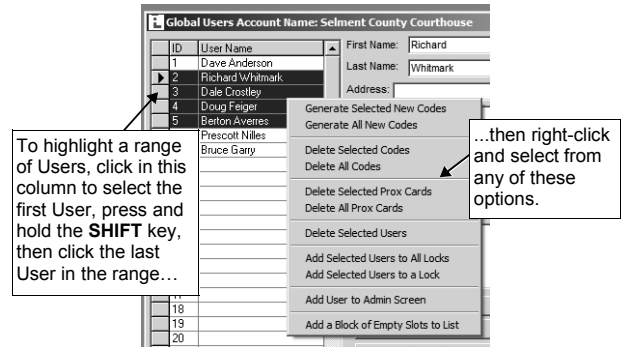

To select a range of Users, click to select the first User, press and hold the **SHIFT** key, then click the last User in the range. Within the range of Users highlighted, right-click in the highlighted area to display the **User Name** list right-click menu. Click a selected action in the menu to perform the action for the selected Users. See the following image:

Random User Code Generation

Random User Codes may be generated for one or many Users. (**Note:** To avoid User Number conflicts, it is recommended to first assign specific User Codes to Users before selecting random User Code generation). To generate random Codes, press and hold the **CTRL** key, click the right arrow ("▶") located to the left of the **User Name** to select each User(s), then right-click and select "**Generate Selected New Codes**". To select a range of Users, click to select the first User, press and hold the **SHIFT** key, then click the last User in the range. Similarly, click **Generate All New Codes** to create new codes for all Users.

Adding a User to a Group/Level

Click on the **Set Group Assignment** button to display this screen:

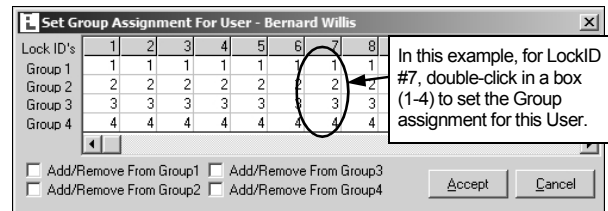

In the above dialog, rows represent Groups and columns represent locks (the number above each column is the LockID number). Double-click in the grid to add the User to a Group in a single lock (hold down the **Ctrl** key to allow single-click entry). To save time, check the appropriate check box to add the User to the same Group in all locks. The same procedures apply to the **Set Level Assignment** button and **Set Level Assignment For User** screen (note that **Levels** are only associated with the DL3000 and DL2800 locks).

Administrative Users

The **Add Administrative Users** button displays the **Set Administrative Users** screen. Administrative Users are the same for all locks within an Account. Enter information the same way as if adding a basic User.



Note: The **ID** column in the **User Name** list is used for identifying Users *in this screen only* and is NOT associated with positions in the **Lock Data** screen. For this reason, if displaying these numbers is confusing, this column may be hidden using the **Options** screen (see page 41 for more information).

The **LockID Grid** displays LockID numbers and is color-coded to describe the state of the selected User:

- Green = User entered in the lock and enabled
- Red = User entered in the lock but disabled
- White = User not in the lock

Double-click on a **LockID Grid** number to cycle through the colors of the LockID number (from *white* to *green* to *red* and back to *white*) thus adding, disabling or removing a User as needed. In this way, the **LockID Grid** can be used to add a User to any lock in an Account. One or multiple Users can also be added to one or more locks via the right-click menu in the **User Name** list.

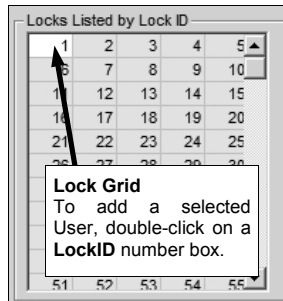

Enroll ProxCards[®] with the AL-PRE

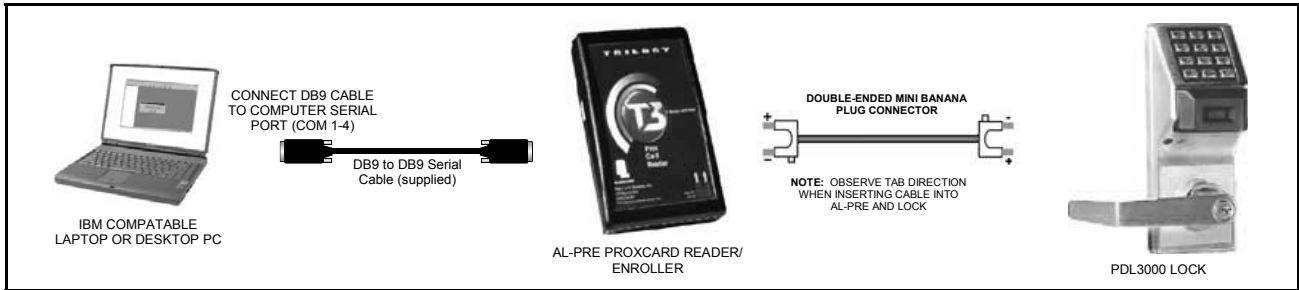

Enroll ProxCards[®] and ProxKey[®] keyfobs quickly into DL-Windows, then transfer this new ProxCARD[®] data from the computer through the AL-PRE to the lock. **For PDL series locks only.**

Setting up the AL-PRE Proximity Enroller

Connect the AL-PRE, lock and computer as shown in the figure below:

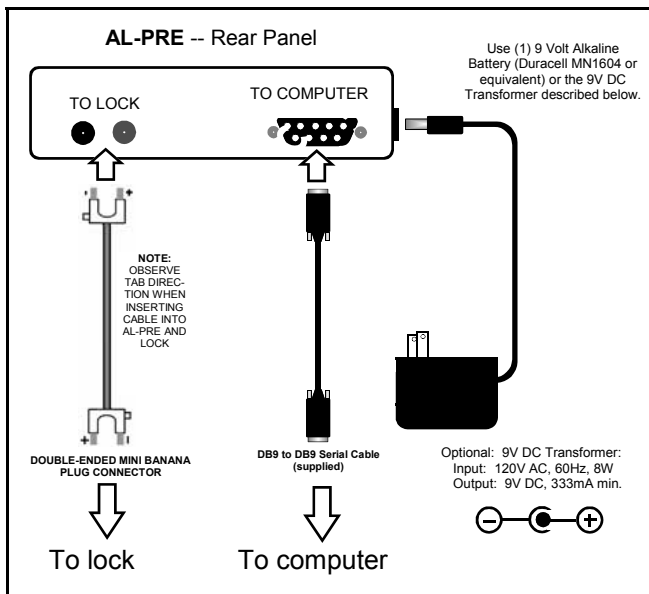

1. Plug one end of the *DB9 to DB9 Serial Cable* into the rear of the AL-PRE and plug the other end into the selected serial COM port in the back of your computer.
2. Insert a 9 Volt battery into the back of the AL-PRE, or plug a 9V DC transformer plug into the side of the AL-PRE.

Add ProxCards[®] and ProxKey[®] Keyfobs with the AL-PRE

1. Open DL-Windows, press **Open**, select the Account and double-click the lock you wish to update with Prox information. The **Lock Data** screen appears.
2. Press the **Global** button (shown at right) and the **Global Users** screen opens. Highlight the User by pressing the *Global ID* column of the User you wish to associate with the ProxCARD[®] or ProxKey[®] keyfob.

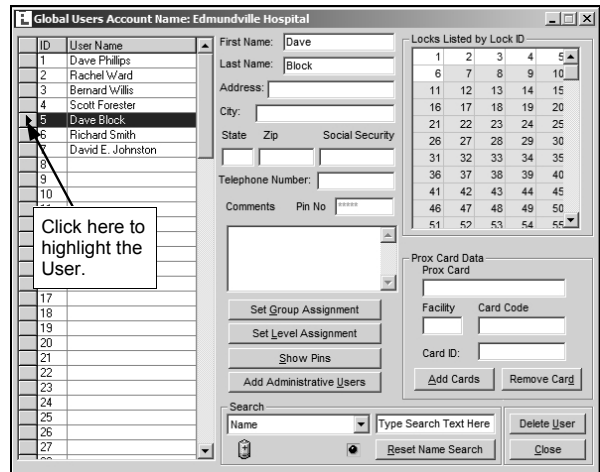

3. On the AL-PRE, press the red **Push On** button.

Note: If the AL-PRE is inactive (no ProxCards[®] are being read) for 5 minutes, the AL-PRE will turn off automatically. Press the **Push On** button on the top of the AL-PRE to "wake up" the AL-PRE.



4. In the **Global Users** screen, click the **Add Cards** button. The **ProxCARD Enrolling** dialog opens. The AL-PRE is now ready to accept Prox entries.
5. In the **ProxCARD Enrolling** dialog (right), check **Enable AL-PRE**.

(continued)

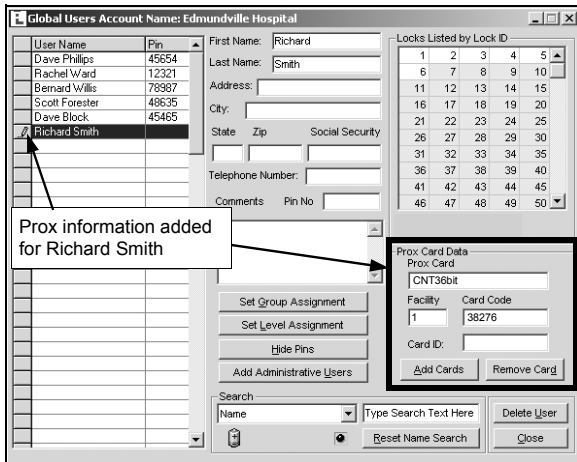

Note: All proximity information for the selected User will be removed from all locks in the Account. When the warning dialog appears, press **Yes** to delete the proximity information.

Add Prox Information--Without the AL-PRE

NOTE: You will need to know the Card Format, Badge Number and Facility Code.

In the **Global Users** screen, in the **ProxCard Data** area, press the **Add Cards** button. The **ProxCard Enrolling** dialog opens (below). To manually add proximity information, first uncheck **Enable AL-PRE**. The **Card No.** and **Facility** fields become active, as shown in the following image:

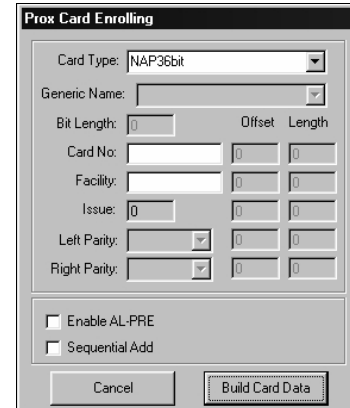

6. Select the Prox card type from the "Card Type" drop down box.

Card Type Dropdown Box:

There are a few pre-existing Card Types. If your Card Type is not listed or is unknown, select the "Unknown" type. Selecting "Unknown" will allow you to enter your card into the system and then assign a badge number (for tracking purposes only) in the **Global Users** screen. Note that this feature is only supported when the AL-PRE is connected to the computer.

7. Place a ProxCard® or ProxKey® keyfob in front of the area of the AL-PRE labeled "Badge Target" until you hear two quick beeps. The **ProxCard Enrolling** dialog closes and the ProxCard® Data fields in the **Global Users** screen become populated, indicating the Prox device has been enrolled for that User (see below image). Notice that in the **Global Users** screen, those Users listed in the **User Name** and **Pin No.** columns with Prox information are tinted yellow.

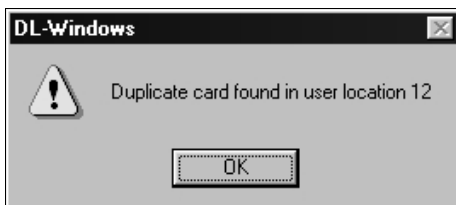

Note: If a previously enrolled ProxCard® or ProxKey® keyfob is presented a second time for enrollment, a popup warning appears similar to the image shown above.

If you choose to add the Proximity data manually, you will need to know the card format, badge number and Facility Code. **DO NOT GUESS AT THE CARD TYPE!** The card number and Facility Code you enter will be the numbers displayed and used by the system. *Data entered and accepted by the system does not mean that the data is verified as correct.* To verify you have selected the correct card type, perform the following verification procedure:

Prox Card Verification Procedure:

NOTE: You will need an AL-PRE in order to complete the verification process.

Manually enter the card information for your selected card type, then click Build Card. The Prox Card Enrolling dialog closes and the **Global Users** screen opens with your Proximity card information populated. Using the AL-PRE, perform a search with your newly enrolled card. In the Search pull-down box select "Prox Card (AL-PRE Needed)" and present the card to the AL-PRE enroller. If your card is found, then the entered data is correct. This process may be performed for all Proximity card types and serves as a means of verifying your entered data.

Sequential Add

When adding Proximity information with known Card Numbers in a sequence, select the **Sequential Add** check box. Sequential Add is supported when using the AL-PRE or when entering the data manually.

In the **Number of Cards** dialog, enter the number of cards you will add sequentially, and click **OK**. The cards will be added starting with the first User selected when the **ProxCard Enroll-**

Remove Cards

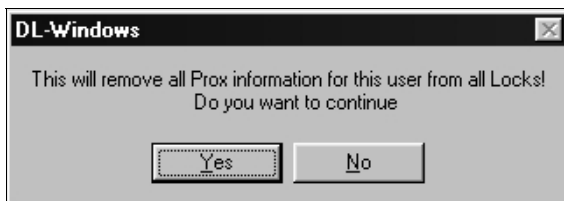

In the **Global Users** screen, highlight the Global ID of the User you wish to edit, press **Remove Card** to remove ProxCard® or ProxKey® keyfob data.

(continued)

Creating Schedules and TimeZones

Schedules are customized by the use of two screens. The first is the **Schedule - Timezone** screen. Click the **Sched** button or click **Window, Schedules** to open.

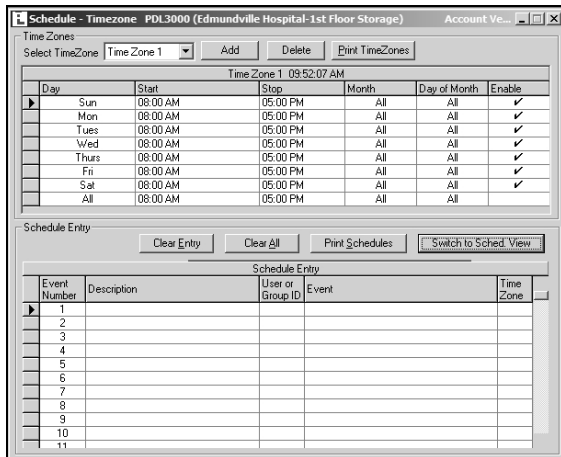

Use the **Schedule - Timezone** screen to create schedules. Just as each schedule consists of two main parts: the action the lock will perform (an *event*) and a time the event will occur (a *TimeZone*), the **Schedule - Timezone** screen contains two main sections:

- A **TimeZone** section (top) - Allows the creation of *TimeZones*, i.e. the time(s) the events in the schedule will take place
- A **Schedule Entry** section (bottom) - Allows the selection of events the lock will perform and links events to *TimeZones*.

The second screen is the **Schedule View** screen. Click the **SchV** button or click **Window, Schedule View** to open.

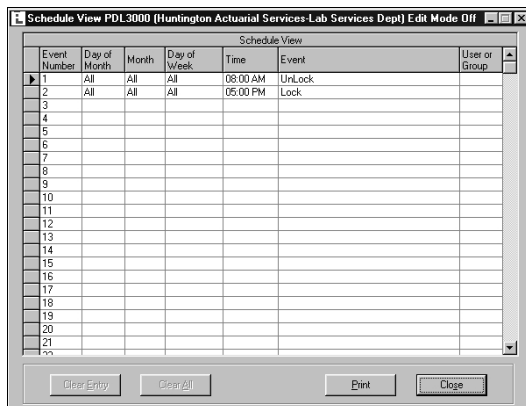

The **Schedule View** screen separates the *TimeZone*(s) for each schedule, clearly displaying ALL parts of the schedule. The **Schedule View** screen also displays the schedule as it is executed by the lock programming. Although the previously described **Schedule - Timezone** screen may display only limited *TimeZone* information, the complete schedule may in fact consist of multiple events depending on how the *TimeZone* was created. Therefore the **Schedule View** screen

is very useful in that it presents the "complete picture", displaying all parts of the schedule, for each schedule you have to work with.

Working with Schedules

Note: Schedules are local to the lock and not shared, while *TimeZones* are *global* and will appear in all lock configurations within an Account.

When selecting the events and *TimeZones* for your schedules, you may need to specify the **User or Group ID** in order to complete the event. The **Description** field is used to display descriptive text for identification purposes only. The **Event Number** records and monitors ALL events stored or sent to the lock.

Schedules can be *single-ended* or *double-ended*: single-ended schedules have a start time only; double-ended schedules have both a start and stop time. Most schedules are double-ended.

An example of a single-ended schedule is a single "Lock" event with the *TimeZone 1* start time set to 5:00 PM only. This schedule will cause the device to lock every day at 5:00 PM. An example of a double-ended schedule is an "Unlock" event with the *TimeZone 1* start time set to 8:00 AM and the stop time set to 5:00 PM. This schedule will cause the device to unlock every day at 8:00 AM and lock at 5:00 PM.

Event Types

Unlock – Device unlocks at programmed time.

Lock – Device locks at programmed time.

Disable Group – All Users within specified Group become disabled at the programmed time.

Enable Group - All Users within specified Group become enabled at the programmed time.

Disable User –Specified User is disabled at programmed time.

Enable Group - Specified User is enabled at programmed time.

Passage Mode by Group 1- Open Window – Places device into *Passage Mode* (unlocked state) when a member of Group 1 enters their User Code. The Start Time opens the timeframe where the Group 1 member can enter their code, the Stop Time ends the timeframe (closes the window).

Note: If a Group 1 member has placed the device into *Passage Mode*, the device will not exit *Passage Mode* automatically. Be sure to lock manually or schedule a single-ended *Lock* event to coincide with the End Time.

Relay Activation by Group 1 – Open Window – Sets a timeframe where if a Group 1 member enters their User Code, a relay activation is sent. An example application of the relay is to disarm an alarm control panel.

Enable Group 4 by Group 1- Open Window – Sets a timeframe where if a Group 1 member enters their User Code, all members of Group 4 will become enabled.

Note: Group 4 will remain enabled if a Group 1 member has entered within the specified time. Be sure to disable Group 4 manually, or schedule a single-ended *Disable Group* event to coincide with the End Time.

Switching to Schedule View

The **Schedule View** screen can be used to verify the full details of each schedule, allowing you to review the arrangement of the start and stop times for each event. The **Schedule View** screen is also intended to be used to view existing schedules received from installed locks.

Send/Receive Information to/from the Lock

Communication Overview

There are two methods for sending data to (or receiving data from) a lock. One method is Direct PC communication to the lock and the other method is to use the AL-DTM-III (Data Transfer Module).

When using a PC for communication, several options may be used for sending and receiving data. The data transmission may be segmented into User information, Schedules, Features Group Status and Time/ Date or All segments may be sent at one time. It is recommended that all data be sent at one time as this is also how the AL-DTM-III functions.

When using the AL-DTM-III, one of three options may be selected: "Send Program to Lock", "Receive Program From Lock" and "Receive Log".

The following page includes instructions for the PC communication method. Please refer to the AL-DTM III section (see page 25) for AL-DTM-III communication instructions.

First time use of DL3000 / DL2800 locks

The Master Code MUST be changed at the keypad for all DL3000 / DL2800 locks before any other programming can begin. Once the Master Code has been changed, Users may be added to the lock and the PC-download function (Function 58) may be accessed. The DL3000 / DL2800 locks do not support a PC-Download User Code (User Code 298 in all other lock models).

Please note that the above only applies to the DL3000 / DL2800 locks. All other lock models support the special function User Code 298 and do not require the Master Code be changed to access Program Mode (to access Program Mode, please refer to the appropriate lock programming manual).

IT IS RECOMMENDED THAT THE DEFAULT MASTER CODE BE CHANGED ON ALL LOCKS TO MAINTAIN SECURITY!

Special Function Communication User Codes

User 298

Entering the User 298 User Code eliminates the necessity of entering a Master or Manager Code, entering Program Mode, and inputting Function 58. Simply enter User 298's User Code to initiate PC communications with the lock. It is an option with all the locks except the DL2800, DL3000 and the PL series models.

User 299

Enter the User 299 User Code to initiate communication between the AL-DTM-III and the lock. The User 299 code is used only for the AL-DTM-III and will not allow passage at the lock. This User does not require programming knowledge of the locks or of DL-Windows; the User simply connects the AL-DTM-III to the lock and enters the User 299 User Code at the keypad.

Consult the specific lock programming manual to program User Codes 298 and 299.

LockID

The "LockID" is a method of ensuring that the correct data is communicated with the intended lock. Once the LockID is set, an error message appears if information is accidentally sent or received by the wrong lock.

Beginning with DL-Windows version 3.5.x software, what was previously named the "Door Number" is now referenced as the "LockID". This name change was made to accommodate a Door Number greater than 96. As a result, utilizing Function 59 at the lock keypad is no longer supported by DL-Windows (version 3.5.x or greater) and the new version of the software must now be used to assign or change the LockID. With this new system, a LockID number of 1 through 2000 is used.

When using a PC to communicate directly with the lock, the LockID is sent to the lock when Send "All" data or Send "Features" is selected. When "Send Program To Lock" is selected as the AL-DTM-III function, the LockID will be sent. (See following sections for explanations on these send options).

Sending Data directly to the Lock from the PC

Connect the AL-PCI2 cable's DB-9 connector to a Serial Port at the rear of your PC (if your computer does not have an available Serial Port, a USB adapter is available – refer to *Product Communication Examples* section in this manual). Connect the other end of the AL-PCI2 cable to the lock, observing tab direction (tab to black socket). The comm port setup is covered in the rear of this manual.

1. In DL-Windows, click the **Comm** button on the DL-Windows toolbar and select **Send to Lock**.

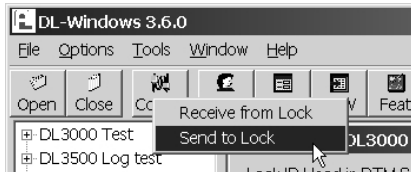

2. The **Send to Lock** dialog box appears:

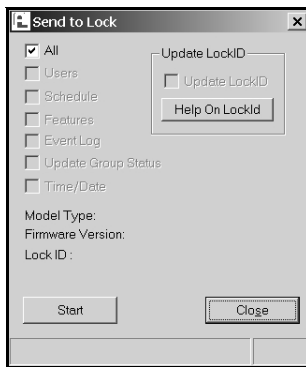

3. Start the communication at the lock keypad by either pressing the special function User 298 User Code at the keypad or by entering Program Mode and accessing Function 58, then click the **Start** button in DL-Windows. "Verifying Lock Type" appears in the status window located at the lower left corner of the **Send to Lock** dialog box (see image below).

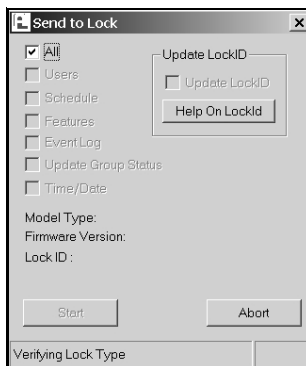

4. The *Model Type*, *Lock Firmware Version* and *LockID #* will display on the screen. Verify that this information is correct.
5. If "Communicating" is not displayed after Step 3 (as shown in the image below), then communications have failed. Check the following:
 - a. COM Port Selection
 - b. Cable Connections

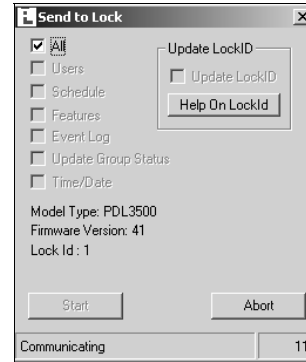

6. After the selected data transfer is complete, verify that the message "Send To Lock Successful" is displayed in the status window of the **Send to Lock** dialog box.

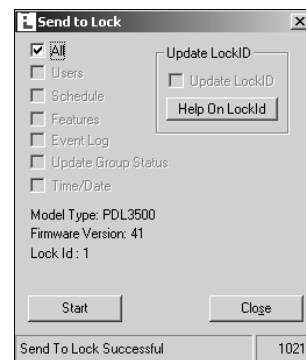

Deselecting **All** allows you to send any combination of available data, i.e. only User Codes and Schedules, Features, Update Group Status, Time and Date or in any combination.

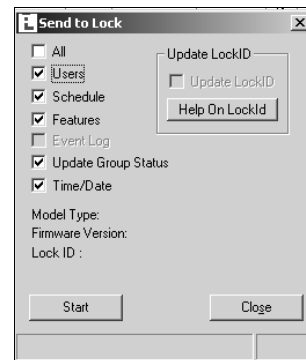

- **All** - Sends the complete program to the lock.
- **Users** - Sends all User Information including User Enable/Disable status, User Codes, Group Assignments, and Level Assignments (DL2800/ DL3000 only)
- **Schedule** - Sends all schedules (see Schedule section for more details)
- **Features** - Sends all features chosen in the Features screen (see Features section for more details)
- **Update Group Status** - Updates the Enabled/ Disabled status of Groups
- **Time/ Date** - Sends the PC's current time and date.

Receiving data from the lock is equally as simple, as described in the following section.

Receiving Data from the Lock

Receiving data from the lock is handled in a similar way as sending data to the lock. You can selectively decide what you want to receive from the lock (i.e. User Data, Schedules, Features or the Event Log). Use "Receive from Lock" to review changes to Users made at the lock.

As with the **Send to Lock** function, the **Receive from Lock** function is selected by clicking the **Comm** button on the DL-Windows toolbar, and then clicking **Receive from Lock**. The following dialog box appears:

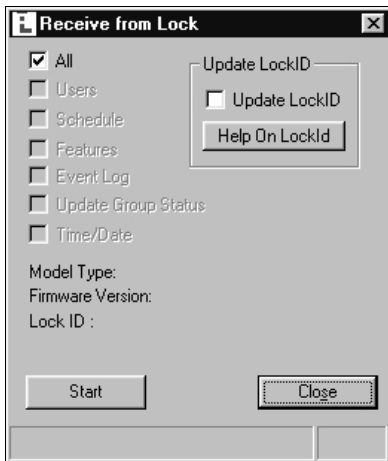

Uncheck **All** if you wish to select individual segments of the lock to be received.

Receive User Information

If any of the Users entered at the lock keypad were found to duplicate existing User Codes in DL-Windows, the following screen will appear detailing those User(s) affected:

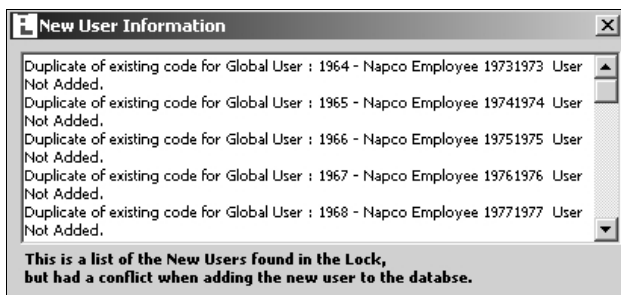

DL-Windows will not allow duplicate User Codes. Changes to these duplicate codes should first be made in DL-Windows and then sent to the lock.

Lock Differences

The appearance of the **Lock Differences** screen indicates that disparities were found between the information stored in DL-Windows and the information found in the lock.

Two types of events can occur to cause the **Lock Differences** screen to appear. The first is if new Users are added to the lock. The second is if changes to Users that exist in DL-Windows are made at the lock. When a "Receive All" or "Receive Users" is performed, DL-Windows will recognize these "differences" and display them in the following screen:

User No.	User Status	State	Prox Card	PC Code	Lock Code	Group 1	Group 2	Group 3	Group
22	Added		No Card		482899		Added		
23	Added		No Card		406861		Added		
24	Added		No Card		930246		Added		
25	Added		No Card		360091		Added		
26	Added		No Card		539399		Added		
27	Added		No Card		814523			Added	

The differences can be *User State* (enabled / disabled), *Prox Card* information, *User Code*, *Group Status* and *Level Status* (DL2800/ DL3000 only). The screen tells you that there are differences, and you must make the changes in DL-Windows if you want them to be permanent. The columns in the **Lock Differences** screen are defined as follows:

User Status – The **User Status** column displays either *Modified* or *Added*.

Modified - Indicates that certain User data already exists in DL-Windows, and this User data was changed at the lock. Because DL-Windows will not automatically receive and accept User changes made at the lock, if you wish to retain the data displayed in the **Lock Differences** screen you must *manually* enter this data into DL-Windows.

Added - Indicates that DL-Windows has updated its software to include this User data (for "non-Admin" Users only). This User data did not previously exist in DL-Windows and no conflicts existed with any other User data in DL-Windows. **Note:** All additions or changes made to *Admin* Users at the lock keypad will display as "Modified", and will NOT be added to DL-Windows. Changes made to Admin Users MUST always be made in DL-Windows.

State – Indicates the existence of conflicting information regarding the Enabled/ Disabled status of the User.

Prox Card (on "P" series lock models only) – Displays proximity card information.

PC Code – Displays the User Code in DL-Windows and indicates the conflict with the **Lock Code** (the **Lock Code** is the User Code added at the lock).

Lock Code – Displays the User Code added at the lock.

Group 1 to 4 – Displays the Group assignment(s) of the User at the lock compared with DL-Windows. *Added* indicates that the User was added to the specified Group at the lock. *Removed* indicates that the User was assigned to the Group in DL-Windows, but was removed from the Group at the lock.

Level 1 to 4 (DL2800/ DL3000 only) – Displays Programming Levels for the User at the lock compared with DL-Windows. *Added* indicates that the User was added to the specified Programming Level at the lock. *Removed* indicates that the User was assigned to the Programming Level in DL-Windows, but was removed from that Programming Level at the lock (see lock programming manual for User Level definitions).

Receive Schedules

All schedule information received from the lock will be displayed in the **Schedule View** screen, and any pre-existing schedules in the **Schedule View** screen will be overwritten. See the **Creating Schedules and TimeZones** section for more information.

Receive Event Log

When receiving the Event Log from the lock into DL-Windows, the log can be viewed in the **Event Log Viewer** screen.

Note: By default only the last 50 events are received from the lock. To receive more events, select the number of events in the **Max. Event Log Length** pull-down list (as shown in the image below). When using a PC, the complete log (up to a maximum of 40,000 events) can be received.

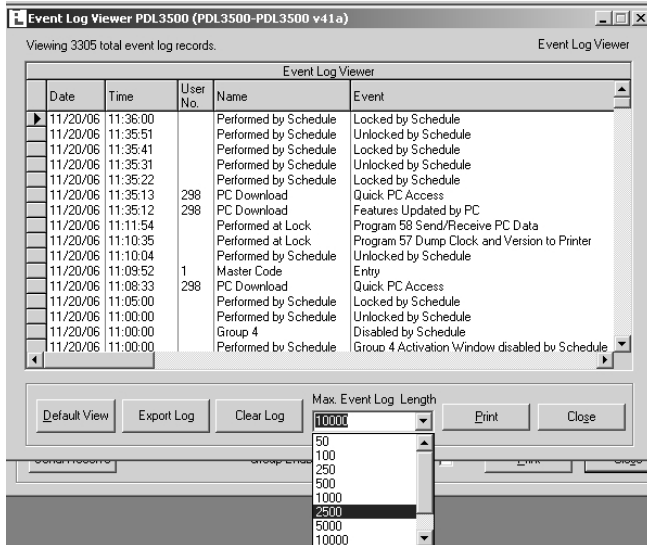

Receive Update Group Status

When **Update Group Status** is selected in the **Receive From Lock** dialog box, the Enabled/ Disabled status of the Groups is obtained and can be viewed in the **Lock Data** screen. A checkbox will appear for Groups 1 to 4, and all Groups checked are Enabled.

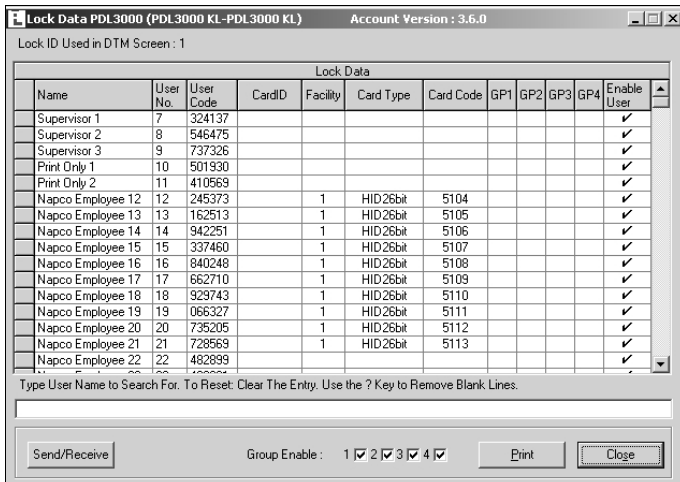

Configure the AL-DTM

The AL-DTM may be configured for Foreign Language support and the *Door Select* feature (see below). **Warning:** Entering the following *Configuration Mode* will clear all data (lock information) from memory.

1. Place AL-DTM into **PC COMM MODE**. If not already in **PC COMM MODE**, press green button to enter this mode.



2. Press and **HOLD** both the left and green buttons on the AL-DTM. After several messages appear, *release the buttons* when the display reads:



(Release buttons when displayed)

When the display reads "**CONFIG. LANGUAGE**", the AL-DTM has entered *Configuration Mode*.

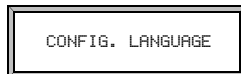

Note: Pressing the green button allows you to step through each configuration option in turn; after the last option, the list repeats ("**CONFIG. LANGUAGE**" re-appears).

3. If you wish to configure the first option, *Language*, press and hold the green button (otherwise press and release the green button to skip to the next option shown in step 4).



Set the language (as shown above) with the left and middle black buttons, then press the green button to select the language AND exit this option.

4. The next option appears: **CONFIG. FOR DTM-III MODE**. For DL-Windows 3.5x and above, this mode **MUST** be set to "**ON**". Therefore, enter this option by pressing and *holding* the green button. The following screen appears:



As shown above, the default setting is "**ON**". Press the green button to both select DTM-III mode and exit this option.

5. The next option appears: **CONFIG. DOOR SELECT MODE**. Enter this option by pressing and holding the green button. The following screen appears:

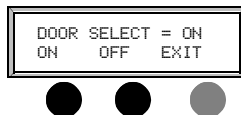

As shown above, the default setting of "**ON**" should be retained if LockID numbers have not yet been programmed and you wish to use the AL-DTM to assign a LockID number to existing locks, or if LockID numbers are to be changed. Otherwise set *Door Select Mode* to "**OFF**". Press the green button to select and exit this option.

6. Additional configuration and diagnostic options display in turn

on each press of the green button; when **SLEEP THEN POWER DOWN** appears, press and hold the green button to exit *Configuration Mode*. **Note:** **UNCONDITIONAL FLASH ERASE** erases all lock information and configured settings in the AL-DTM. To reset the AL-DTM to its factory default settings, remove the battery, press and hold the green button for 10 seconds, then replace the battery.

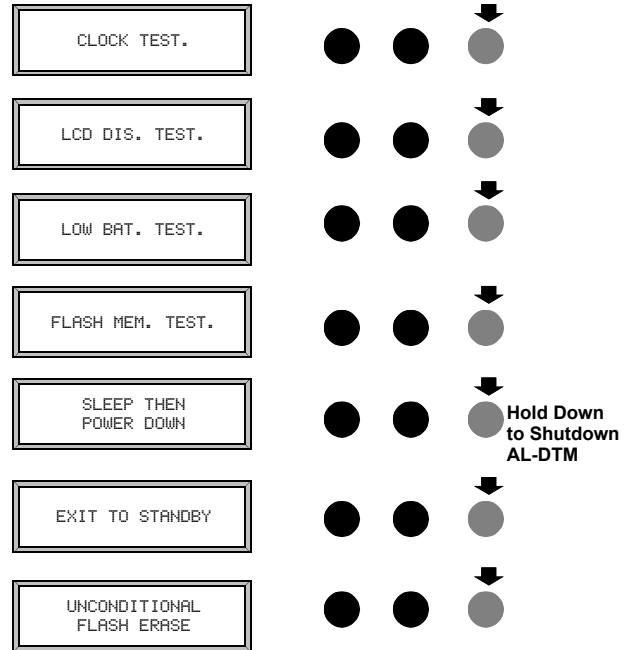

7. The unit may now be powered up with the new feature(s) enabled.

Operation Mode

Once AL-DTM is configured, it is ready for use. If *Door Select Mode* was set to "**ON**" (in step 5 above), then the AL-DTM will power up in "**OPERATION MODE**", which offers two choices: **SELECT** and **STD**:

SELECT – If *Select Mode* is chosen (by pressing left button), you can choose between three modes: *PC Comm Mode*, *Lock Mode*, and *Door Select Mode*:

- *PC Comm Mode* is used to transfer programming between the PC and the AL-DTM.
- *Lock Mode* is used to transfer information between the AL-DTM and the Locks. The AL-DTM will automatically identify the LockID to which it is communicating.
- *Door Select Mode* is used to transfer program and assign LockID numbers from DL-Windows.

STD ("standard") – *Standard Mode* will automatically put AL-DTM in **PC COMM MODE** when communicating with DL-Windows and will put the AL-DTM in **LOCK MODE** when performing communications with the locks. *Standard Mode* should be used for all subsequent communication after LockID has been assigned.

Note: The AL-DTM will only allow the selection of a LockID for which it has valid data currently programmed. *Care must be taken to that ensure the correct data is being transferred to the correct lock.*

Send Data from DL-Windows to the AL-DTM

Introduction

When computers cannot be transported or when electrical power is not available, the hand-held **AL-DTM** device acts as a go-between—it allows the transfer of lock data from the computer (through the **AL-DTM**) and to the lock, or in reverse (from the lock through the **AL-DTM** back to the computer). An **AL-PCI2** cable is required when transferring from your PC to the AL-DTM. A double-ended mini banana plug connector is used when transferring data from the AL-DTM to the lock(s).

Prior to DL-Windows v3.5, *Door Numbers* were used to ensure that each physical lock was correctly matched to its corresponding data when programmed. **With DL-Windows v3.5 or later**, the concept of a *Door Number* has been discontinued in favor of a new system of *LockID's*. When communications take place between DL-Windows and the lock(s), the LockID's must match in order for the data transfer to take place. If they do not match, communications will halt!

DL-Windows must be used to assign LockID's and this can be performed in two ways, either:

- communicating directly with either "Send All" or "Send Features", thus updating the locks with the new "LockID" system

--or--

- with the AL-DTM, "Send Program to Lock" in the AL-DTM's **Door Select Mode** (see *Configure the AL-DTM* on page 25).

Door Select Mode should only be used when it is necessary to assign a LockID (usually first time programming of lock only). Thereafter, ANY AL-DTM communications should be performed in the "**Lock Mode**" of the AL-DTM. This will ensure that the information is being communicated correctly between DL-Windows and the Lock(s).

The AL-DTM displays the word "Door" and not "LockID" when referring to door numbers (in the AL-DTM, both words are equivalent).

Be sure to make note of the EXISTING User 299 User Code. You will need this code(s) later when transferring data from the AL-DTM to the lock(s). (See page 8 for a definition of User 299)

Send Program to Lock

1. Plug the AL-PCI2 cable into the correct COM port in your PC and plug the 2-pin banana plug connector into the AL-DTM, observing correct tab direction.
2. Open an Account in DL-Windows, and double-click on any lock inside the selected Account. For each physical lock to be programmed there must also be a corresponding lock in DL-Windows.
3. Click the **DTM** button and the **DTM Support** screen opens. In this screen, desired tasks must first be pre-programmed in the **DTM Function** column. Therefore, for each lock that is to receive program data, click in the **DTM Function** column for the selected lock, click this arrow and the pull-down menu will display. Select the "**Send Program to Lock**" function.

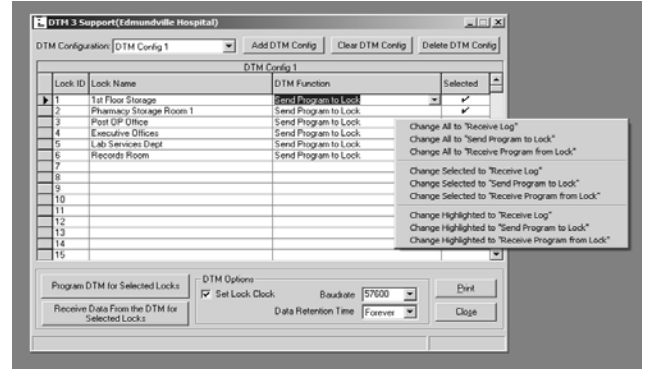

DTM Function - Right-click within in the *DTM Function* column.

To send program to ALL locks available, right-click in the *DTM Function* column and click **Change All to "Send Program to Lock"**.

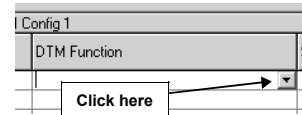

The AL-DTM also gives you the option of setting the date and time of the lock (using the PC time). In the **DTM Options** box at the bottom of the screen, the "**Set Lock Clock**" is selected by default.

4. **Transfer the Data Configuration to the AL-DTM.** With the AL-PCI2 cable correctly connected to the AL-DTM, click **Program DTM for Selected Locks** (in the **DTM 3 Support** screen). The following window will display:

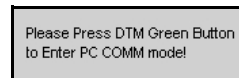

Press the green button on the AL-DTM to enter 'PC COMM MODE'. During data transfer to the AL-DTM, the following will display in the AL-DTM readout screen:



Following a successful data transfer to the AL-DTM, the AL-DTM will emit several beeps (beeps are dependent on configuration Data) and display a "**Comm. Complete.**" message followed by a display of current memory block status.

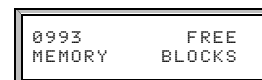
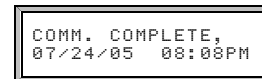

The AL-DTM, now filled with data, is ready to transfer the data to the selected locks. The following messages will scroll back and forth on the AL-DTM.

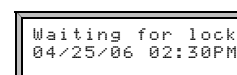
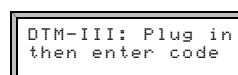

Send Data from the AL-DTM to the Lock

Transferring Data from AL-DTM to Locks for the first time

1. **Connect the AL-DTM to the Lock.** Connect the double-ended banana plug into the AL-DTM and into the lock that is to be programmed (observing proper tab direction).

2. **The AL-DTM will display the LOCK MODE screen,** press the green button to toggle through the following screens:



3. Toggle screens to display **DOOR SELECT MODE**, then select **YES** by pressing the left AL-DTM button.

4. The screen displays **"Set Door TO=0001"**. The number "0001" refers to the lock assigned LockID # 1 in DL-Windows. If this is the first lock to be programmed, press the green button (SET). (To choose a different lock, the left AL-DTM button will toggle back through the list of locks and the middle button will toggle forward).

5. The screen displays **"Ready, Door=xxxx"** (xxxx = LockID). Press left button (**GO**) and the screen will then switch between:

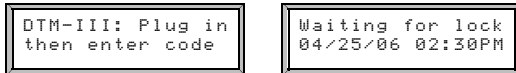

6. **Enter the User 299 User Code at the lock keypad.** The AL-DTM briefly displays a message that it is **"Analyzing Lock - Please Standby"** and then displays the following:

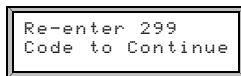

7. Do not press any more buttons, and the AL-DTM will display the following:

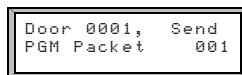

Packet Numbers will go up until all packets have been transferred to the lock. PDL3000 locks will take longer due a larger number of packets (typically 5 times longer than DL3000 or DL3500 locks).

The Lock will continue to beep while in communication with the AL-DTM. After programming is complete, the following will display:

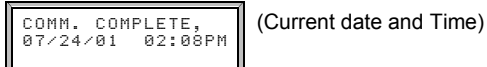

8. **Program Additional Locks.** Repeat Steps for each lock to be programmed. Make sure that each Lock is being assigned the correct LockID. This will ensure that the locks are programmed

as they were set up in DL-Windows as well as ensuring the correct data transfer for all subsequent communication attempts.

DL2800/ DL3000 Only

If the lock's Master Code and the DL-Windows Master Code do not match, then the following AL-DTM screen will display:



In this case, the solution is to either use the lock keypad to re-program the Master Code--or--re-configure the AL-DTM (using DL-Windows) so that both Master Codes match.

Transferring Data from AL-DTM to Locks (Changes)

After the initial programming of the locks with the AL-DTM, *Door Select Mode* is no longer required. AL-DTM should now be used in *Standard Mode* (Lock Mode). All changes can be communicated to and from the locks in this mode.

Receive Event Logs with the AL-DTM

After all lock programming has been completed, the AL-DTM can be easily re-configured to retrieve event logs.

1. In **DTM Support** screen click in the **DTM Function** column for the selected lock, click the down arrow and the pull-down menu will display. Select the **"Receive Log" Function**.

Multiple locks can be programmed to receive logs by right clicking in the **DTM Function** column and select **"Change All to 'Receive Log'."**

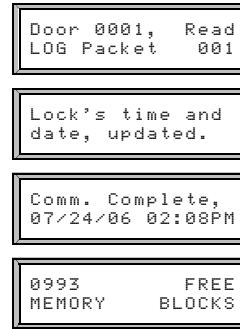
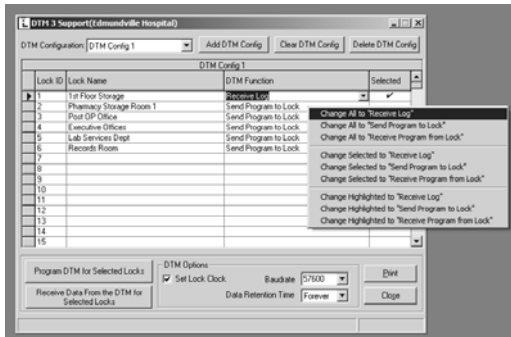

7. **Retrieve Additional Lock Logs** by repeating Steps 4 through 6 for each lock Log to be retrieved.
8. **Reconnect the AL-DTM to the DL-Windows PC (using the AL-PCI2 cable) to retrieve the Event Logs from the AL-DTM.** On the **DTM Support** screen, click **Receive Data From the DTM for Selected Locks** to receive the Event Logs stored in the AL-DTM.

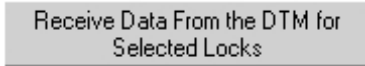

2. Transfer the Configuration to the AL-DTM. Connect **AL-DTM to the DL-Windows PC (using the AL-PCI2 cable)** then click **Program DTM for Selected Locks** to transfer the new configuration to the AL-DTM.



The following window will display:

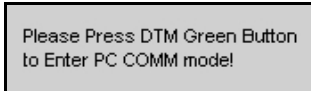

3. **Enter PC Comm mode.** On the AL-DTM, press the green button and the following will display on the AL-DTM:

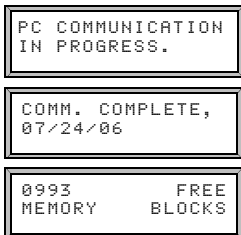

Unplug the AL-DTM. The AL-DTM is now ready to retrieve event logs from the locks.

4. **Connect the configured AL-DTM to the Lock** using the double-ended banana plug cable, observing tab direction.
5. **Enter the User 299 User Code at the lock keypad.** The AL-DTM will briefly display a message that it is "Analyzing Lock" and then will display the following:

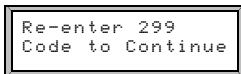

6. **Re-Enter User 299 User Code at the lock keypad.** The AL-DTM will display the following:

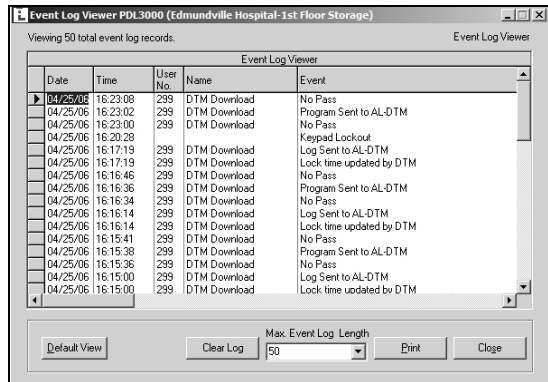

Typical Event Log

Receiving Program with the AL-DTM

The AL-DTM can be programmed to receive the program from the locks. Receiving the program can be a useful tool to monitor additions or changes made at the lock as well as import locks into a new DL-Windows account.

The procedure for receiving the program from the lock with the AL-DTM is similar to receiving logs. Click in the **DTM Function** column for the selected lock, click the down arrow and select the **"Receive Program" Function** in the pull-down menu. Follow the same procedures in the section above to program the AL-DTM and retrieve data from the lock.

Refer to *Receiving Data from the Lock* on page 23 for more information.

"Global Users" Screen - Field and Button Definitions

One building may contain many locks. To add the same User to each lock again and again quickly becomes tedious. The solution is the **Global Users** screen. The **Global Users** screen allows you to enter a User's name and information ONCE, then quickly and easily add this User to any lock (up to 2000) in the Account, as well as designate the User's specific Location Number (within each lock) and User Code (Pin Number). In short, the **Global Users** screen allows you to control the status of all Users inside an Account (usually a single building) as well as their individual Programming Levels for each lock located in the Account.

Press the **Global** button to Access the **Global Users** screen.



User Name
Names appear in this column when **First Name** and **Last Name** fields in this screen are populated. This field turns yellow when both a User Code and Prox information is required. See page 18 for details.

Pin Number
Each User can have the same Pin Number (User Code) for all locks in an Account. It is listed here for ease of viewing. Administrators can hide this column by pressing the **Hide Pins** button. This column is hidden for all other users (non-Administrators). When hidden, this column is hidden in this screen and also in the **Lock Data** screen.

Personal Information
This basic data helps to customize and ensure correct identity.

Locks Listed by LockID
These boxes labeled 1-2000 each represent individual locks in the Account. User status is presented in one of 4 colors:
Gray--Not assigned (no lock exists).
White--User not yet added to lock programming.
Green--User added to lock programming and enabled.
Red--User exists inside lock programming, but is disabled.

("Global") ID
A Global ID is Account specific--it remains constant within Accounts only. A Global ID is **not** related to User Numbers nor Programming Levels, but acts as an internal designation within the program only. **Note:** The Global ID can be hidden from view. See note below.

Click in this column to highlight User and view personal and Account information. In this example, *Dave Phillips* is highlighted, displaying his User data in the window.

Comments
Allows text up to 256 characters.

Pin No.
Same as a *User Code*. Enter changes in this field.

Hide Pins
Allows PIN numbers to be hidden for increased security.

Set Group Assignment
Opens a new window, allowing the assignment of the User to a specific Group within a lock. Also allows a single user to be assigned to different Groups in different locks within an Account.

Battery Icon
The battery icon indicates the charge status of the battery inside the AL-PRE.

Prox Enroll Status
This light indicates the status of the AL-PRE after enrolling a ProxCard®. (Green = OK, Red = Fail)

Search Utility
As User Names start to fill up, this utility saves time.
Search by Name allows a search by either first or last name;
Search by ProxCard® for Prox Number search.
Search by Pin allows a search by User Code (Pin).

Type name here
Enter search criteria (either first or last name, Prox Number or Pin Number)
Reset Name Search
Press to start a new search. Press this button and you lose the results of your previous search.

Delete User
Press to delete User from all locks in the Account, removing all information from the system. (not just disabling)

Close
Press to close window.

ProxCard Data
Use the AL-PRE to enroll ProxCards® and ProxKey® keyfobs, and these fields will automatically populate. Press **Add Card** to open the ProxCard Enrolling dialog. See page 17 for procedures.
Press **Remove Card** to remove all Prox information from all locks.

Add Administrative Users
Allows manual assignment of Users to User Numbers, allowing Users to be assigned to specific Programming Levels within a lock. The range of programming tasks allowed by these Programming Levels are outlined in each lock's programming instructions.

Set Level Assignment
Opens a new window, allowing the assignment of the User to a specific Level within a lock. Also allows a single user to be assigned to different Levels in different locks within an Account. **Note:** Applies to DL3000 and DL2800 locks only.

NOTE:

The **Global ID** is a means of determining how many Users are listed within an Account. This "Global ID number" is used by the program only and has no relationship to where the User is located within a particular lock. The Global ID is **not** a User Number, and does not determine Programming Levels within locks.

Level Assignments are predefined User Types (such as Master, Installer, Manager, Supervisor, and Print Only User). Each possess a specific range of programming tasks they are allowed to perform.

"Set Administrative Users" Screen - Field Definitions

The **Set Administrative Users** screen is used assign Users to the administrative locations within the locks, determining their Programming Levels and therefore defining the range of programming tasks a User is allowed to perform. Press the **Add Administrative Users** button (on the **Global Users** screen) to Access the **Set Administrative Users** screen.

User Name
Names appear in this column when **First Name** and **Last Name** fields in this screen are populated. This field turns yellow when both a User Code and Prox information is required. See page 18 for details.

Pin Number
Each User can have the same Pin Number (User Code) for all locks in an Account. It is listed here for ease of viewing. Administrators can hide this column by pressing the **Hide Pins** button. This column is hidden for all other users (non-Administrators). When hidden, this column is hidden in this screen and also in the **Lock Data** screen.

Personal Information
This basic data helps to customize and ensure correct identity.

Pin No.
Same as a **User Code**. Enter changes in this field.

Comments
Allows text up to 256 characters.

ProxCARD Data
Use the AL-PRE to enroll ProxCards® and ProxKey® keyfobs, and these fields will automatically populate. Press **Add Cards** to open the ProxCARD Enrolling dialog. See page 17 for procedures.
Press **Remove Card** to remove all Prox information from all locks.

Click a row in this column to highlight User and view personal and Account information. In this example, the Master Code is highlighted, displaying the default User information in the window, with the fields ready to be populated.

Administrative Users are special in that they can perform programming tasks that non-Administrative ("Basic") Users cannot perform (such as changing or adding new User Codes, etc.). Some of these Administrative Users are allowed more tasks than others, and the distinction between Users and their allowed tasks is known as a "Programming Level". (See the definition of "Programming Level" on page 7).

Set Group Assignment
Opens a new window, allowing the assignment of the User to a specific Group within a lock. Also allows a single user to be assigned to different Groups in different locks within an Account.

Set Level Assignment
Opens a new window, allowing the assignment of the User to a specific Level within a lock. Also allows a single user to be assigned to different Levels in different locks within an Account. **Note:** Applies to DL3000 and DL2800 locks only.
Level Assignments are predefined User Types (such as Master, Installer, Manager, Supervisor, and Print Only User). Each possess a specific range of programming tasks they are allowed to perform.

Delete User
Press to delete User from all locks in the Account, *removing* all information from the system (not just "disabling").

Press **Accept** to save the information added, and press **Cancel** to discard all entered information.

Administrative Users	User Name	Pin
Master Code	Master Code	123456
Installer 1	Installer 1	
Installer 2	Installer 2	
Manager 1	Manager 1	
Manager 2	Manager 2	
Manager 3	Manager 3	
Supervisor 1	Supervisor 1	
Supervisor 2	Supervisor 2	
Supervisor 3	Supervisor 3	
Print Only 1	Print Only 1	
Print Only 2	Print Only 2	
Enable User 300	Enable User 300	
PC Download	PC Download	67890
DTM Download	DTM Download	
One Time Service	One Time Service	

User Info
First Name: Master
Last Name: Code
Address:
City:
State: Zip: Social Security:
Telephone Number:
Comments: Pin No | 123456

Prox Card Data
Prox Card: Facility: Card Code:
Card ID: Add Cards Remove Card

Buttons: Set Group Assignment, Set Level Assignment, Delete Current User, Accept

"Lock Data" Screen - Field Definitions

The **Lock Data** screen is used to view User Codes, Group Associations and Program Levels inside individual locks.

✓Quick Tip:

After entering Users and assigning Users to Location Numbers ("Slots") by using the **Global Users** screen (see page 29), use the **Lock Data** screen (shown at right) to view and confirm the User Location assignments made inside each individual lock. User Locations determine Programming Levels for each lock.

Remember, Inside each lock:

User Number = User Location = Location Number = Slot

Name	User No.	User Code	CardID	Facility	Card Type	Card Code	GP1	GP2	GP3	GP4	Enable User
Master Code	1	123456									<input checked="" type="checkbox"/>
Installer 1	2										
Installer 2	3										
Manager 1	4										
Manager 2	5										
Manager 3	6										
Supervisor 1	7										
Supervisor 2	8										
Supervisor 3	9										
Print Only 1	10										
Print Only 2	11										
David E. Johnston	12	4567									<input checked="" type="checkbox"/>
	13										
	14										
	15										
	16										

Name

In this field, the **First** and **Last Name** entered in the **Global Users** screen is displayed. The **Name** will appear on any activity reports generated, such as in the **Event Log Viewer** screen. The default labels (such as "Supervisor 1") that appear in the **Name** column when a new lock is created are for reference only. As Users are assigned to each User Number "slots", the **Name** will appear in place of the default values shown.

User No.

This is the User Number inside the lock that determines the Programming Level of each User (see "Terminology" on page 7). **Note:** The PDL series locks can contain up to 2000 Users, and 300 Users for the DL3000/DL3500.

User Code

Also called *User Access Codes* or *PIN No. Codes*, User Codes are numbers the User enters into the lock keypad to unlock the lock or device. User Codes are entered via the Global Users screen. Administrators can hide this column by pressing the **Hide Pins** button. This column is hidden for all other users (non-Administrators).

Card ID

This field is used to physically identify a ProxCards that has been assigned to a User. The number printed on the ProxCards (up to 9 digits) may be typed into this column. This is for reference only.

Facility

The Facility Code is a site code on all ProxCards® and ProxKey® keyfobs, and is usually the same for all ProxCards® (but not printed on the card or fob). Usually, the site administrator can provide Facility Code information.

Card Type

The Card Type specifies the format of the card being used (i.e. HID 37 bit format, etc. See pages 18-19). The Card Type is not printed on the card or fob itself, and usually the site administrator can provide this information.

Card Code

The Card Code is usually laser-printed on the card or fob itself. If not printed on the card, see the site administrator for this information.

GP1 GP2 GP3 GP4

(User Group Association)

Each User can be associated with up to 4 Groups. Groups of Users can be enabled or disabled simultaneously. This User/Group association is typically based on the User's department, or the shift to which the User is assigned. If any User attempts to access the lock outside of the Group's scheduled hours, the lock will deny entry.

Enable

Indicates the current status of the User. If the User is currently enabled, a will appear under the Enable column.

Type User Name to Search

Type in User name to be searched.

For example, enter "Bob". All names with "Bob" in the User Name will display.

Send/Receive

If clicked, the **Send/Receive** button will provide a shortcut to the **Receive from Lock** or the **Send to Lock** communication dialogs.

Group Enable

For DL3500 and PDL Series Locks only. Users that have been assigned a Group number can be enabled/disabled by checking or unchecking the associated box. **NOTE:** Group Enable data is not transferred by the AL-DTM.

Print

Click to send to your default printer all data inside all columns and rows listed in the **Lock Data** screen.

Close

Click to close **Lock Data** screen.

"Event Log Viewer" Screen - Field Definitions

The Event Log Viewer screen is used to view each event (also called the "Audit Trail").

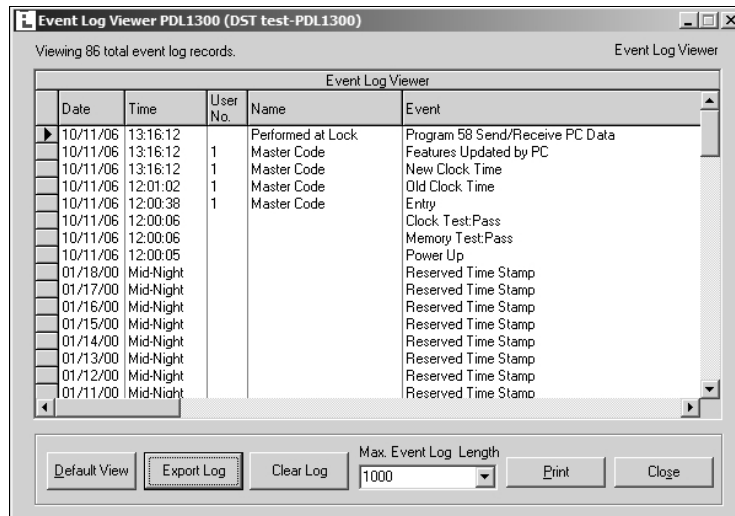

Note: In the Event Log Viewer screen, each column heading (**Date**, **Time**, etc.) can be clicked to sort its data.

Date

The date the event occurred (MM/DD/YY). Click the heading to sort its contents.

Time

The time the event occurred in 24-hour military time. Logs retrieved from the DL3000 with the AL-DTM have an accuracy of one minute, for all other locks accuracy is one second. Logs retrieved with a computer have an accuracy of one second. Click the heading to sort its contents.

User No.

This is the User Number inside the lock that determines the Programming Level of each User (see "Terminology" on page 7).

Name

Most often, this is the name that is entered in the **Name** field on the **Global User** screen. If a name has been entered for the User that is associated with the event, the name of the User will be displayed.

Event

This is a description of the logged event that occurred. Click the heading to sort its contents.

Default View

Clears the Event Log Filter and displays all Event Log Events.

Export Log

Click the **Export Log** button and two selections appear (as shown below): You can click either **Export Log to Text File** or **Export Log to CSV File**.

Export Log to Text File
Export Log to CSV file

If you click **Export Log to Text File**, the log will be saved in the form of a .txt (text) file, and a popup will appear detailing the name and path of the file. **Note:** If the text file is viewed using Courier font typeface in *Notepad*, all columns in the file will align.

If you click **Export Log to CSV File**, the log will be saved in the form of a CSV (Comma Separated Value or *comma delimited*) file, and a popup will appear detailing the name and path of the file. **Note:** This CSV file can be viewed in MS Excel, and each column in the Log will be aligned in Excel under its own column heading.

Max. Event Log Length

Enter the Maximum length of the Event Log list.

Print

Click to send to your default printer the displayed data inside columns and rows listed in the **Event Log Viewer** screen. Only those records displayed (specified in the **Maximum Event Log Length**) will be printed.

Close

Click to close the **Event Log Viewer** screen.

"Programmable Features" Screen - Options tab

The **Programmable Features** screen is used to program lock options and a variety of programmable Features.

Note: Daylight Saving Time features apply to v3.6.0 only. For version 3.5.6, see page 53.

The above screen is from a PDL3000 lock. Note the Daylight Saving Time area includes the 24 pre-programmed modes as well as a 25th mode to allow customization (selecting mode 25 from the pull-down list activates the **Custom DST** button). This screen layout is typical for most locks. For other locks, see the **Daylight Saving Time** description below.

LockID

Door Number must be between 1– 2000*.

If the lock is a new lock without a designated LockID, the ID number specified in this field will be assigned to the programmed lock. If used with the AL-DTM Data Transfer Module, this is the LockID number the AL-DTM will use to identify itself to the lock, insuring that the proper data inside the AL-DTM will be matched to the correct lock.

*Varies with lock model.

Pass Time In Seconds

The duration in seconds that the lock will remain unlocked after a valid code has been entered (valid entries are 3, 10 & 15 seconds).

Entry Delay in Seconds

Delays door entry after valid User code is entered. **Note:** For DL3500 and PDL3000, valid entries are 0, 5, 15 & 45 seconds.

Lockout # of Attempts 1-9

The maximum number of invalid entry attempts (with wrong User Code) the lock will allow before it goes into lockout mode (where it will refuse to recognize ANY User Code entry). The lock will shut down for the period programmed in the **Lockout Time in Seconds** field which follows. Valid Attempt entries are 1-9.

Lockout Time in Seconds

The duration of time the lock refuses to recognize ANY User Codes after the maximum number of invalid entry attempts (with wrong User Code) has been reached (valid entries are 1-60 seconds).

Group 2 Toggles Passage Mode

A Group 2 User will toggle passage mode (lock is unlocked). **Caution! The consequences of accidentally selecting this option can cause a security breach!** (Not applicable to the DL2800/DL3000).

Group 2 Enables and 3 Disables Passage Mode

A Group 2 User will put door into passage mode (lock is unlocked). A Group 3 User will take door out of passage. **Caution! The consequences of accidentally selecting this option can cause a security breach!** (Not applicable to the DL2800/DL3000).

One Time Only for Group 3 Users

If checked, allows Group 3 Users to unlock the door one time only, then their User Code or proximity card becomes disabled. (Not applicable to the DL2800/DL3000).

Star Key as Enter Key

If checked, all codes entered must be followed by the key.

Disable Sounder

Disable Lock Sounder to enable silent operation. (Not available on all locks)

Enable Star Key as Doorbell

Check to allow the key to act as a doorbell. Sounder must be enabled for doorbell operation. (Not available on all locks)

Enable Entry Sounder

Check to enable sounder to activate upon each Access Granted or Remote Input activation. (Not available on all locks)

Daylight Saving Time (v3.6.0 only)

The lock will adjust for Daylight Saving Time. Daylight Saving Time configuration settings for the PDL3000 lock are shown above (most other locks similar) allowing 23 pre-set modes for the varied DST adjustments throughout the world. Select mode "1" for no DST adjustment and select mode "25" and click the **Custom DST** button for custom settings. For other locks, custom settings and more details, see next page.

Daylight Saving Time area for DL3000 / DL2800 locks: Check the box to activate the **Custom DST** button. See next page for details regarding the **Custom DST** button and customizing the DST start and end dates. See page 34 for a list of Locks and firmware versions that support the new Daylight Saving Time feature.

Daylight Saving Time area (for locks other than the DL3000/DL2800): If Daylight Saving Time is elected to be used, select mode **25 - Custom Daylight Saving Time** from the pull-down list to activate the **Custom DST** button. See next page for details.

Door Ajar

For use with the DL/PDL3300 lock. Check **Enable Door Ajar Monitoring** to enable this feature. Check **Door Ajar Trip Time** (delay time in seconds after the door first becomes slightly open) from the drop-down list, and check **Use Sounder on Door Ajar** to enable an audible warning upon a valid door ajar trip.

"Programmable Features" Screen - Customize DST

Daylight Saving Time features below apply to v3.6.0 only.

The **Programmable Features** screen, *Options* tab will vary depending the lock model, as shown below. Some locks require either DST be disabled or customized, other locks also allow the selection of pre-set DST modes for the varied DST adjustments throughout the world. **For version 3.5.6, see page 53.** Set Daylight Saving Time configuration settings as follows:

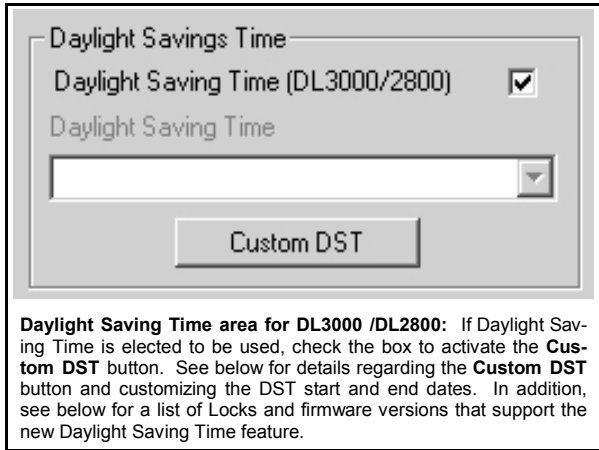

Daylight Saving Time area for DL3000 /DL2800: If Daylight Saving Time is elected to be used, check the box to activate the **Custom DST** button. See below for details regarding the **Custom DST** button and customizing the DST start and end dates. In addition, see below for a list of Locks and firmware versions that support the new Daylight Saving Time feature.

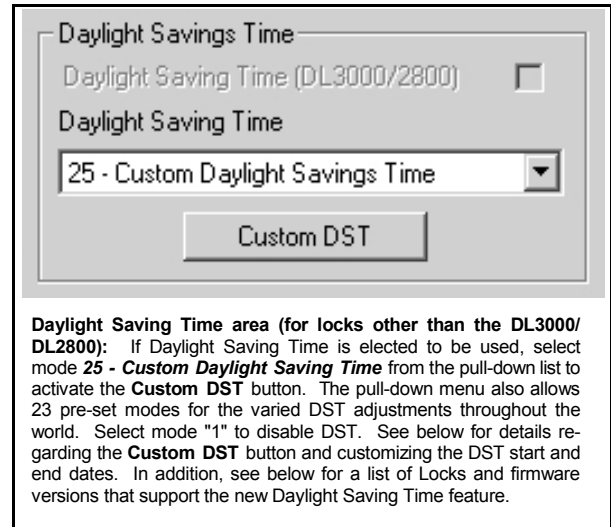

Daylight Saving Time area (for locks other than the DL3000/ DL2800): If Daylight Saving Time is elected to be used, select mode **25 - Custom Daylight Saving Time** from the pull-down list to activate the **Custom DST** button. The pull-down menu also allows 23 pre-set modes for the varied DST adjustments throughout the world. Select mode "1" to disable DST. See below for details regarding the **Custom DST** button and customizing the DST start and end dates. In addition, see below for a list of Locks and firmware versions that support the new Daylight Saving Time feature.

In any of the screens above, click the **Custom DST** button and the following dialog appears:



The default Start and End dates are set to the new DST laws enacted for 2007 in the USA:

- Start Date: *Second Sunday in March*
- End Date: *First Sunday in November*

To customize these dates, click the pull-down menu and a calendar will appear:

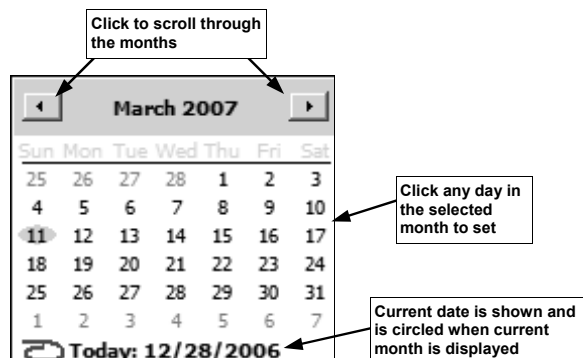

You can also click within the pull-down list to highlight the numbers and type in the digits manually:

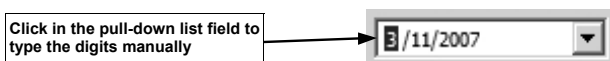

Repeat to select the End Month/Day.

Daylight Saving Time customization is only supported with the locks listed in the chart located at the bottom of this page.

All DST adjustments will take place at 2:00 AM the days selected.

Click **OK** to save and click **Cancel** to discard changes.

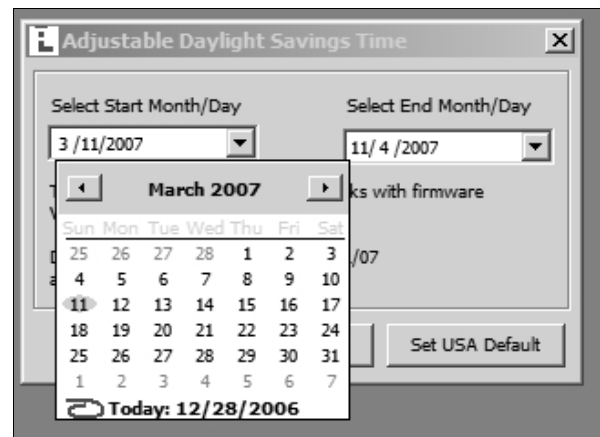

Click the pull-down menu and a calendar will appear.

Locks and firmware versions that support the new Daylight Saving Time feature:

- DL1300 v38d
- PDL1300 v39e
- DL2800 v35g
- DL3000 v34k
- PDL3000 v40b
- DL3500 v14i
- PDL3500 v41a

"Programmable Features" Screen - *Relay Functions* tab

The **Features** screen is used to program Relay Functions and other programmable Features. If programmed, **one or more** of the following relay Functions will activate an external Relay for an interval of 3 seconds, if the condition is met. If **Relay follows Lock/Unlock Status** is selected, the relay will remain activated as long as the door is unlocked.

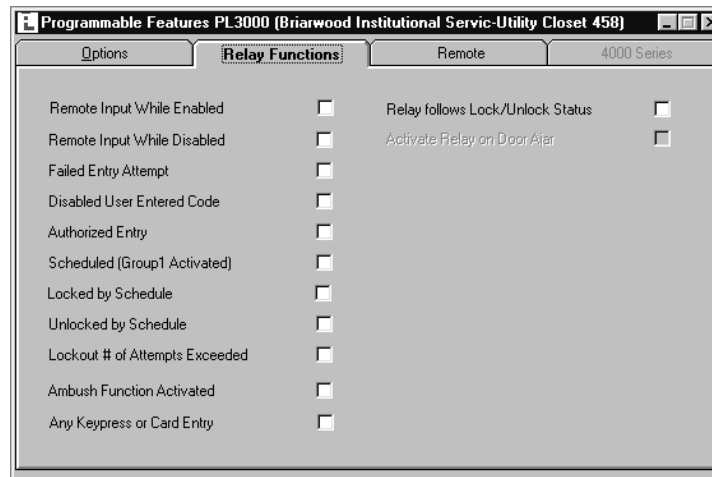

Select any of the Functions below to Activate the Relay Output (more than one may be selected).

Remote Input While Enabled

Will activate relay when the Remote Release is activated. This will provide an alert that access has been granted via the Remote Release.

Remote Input While Disabled

Will activate relay when the Remote Release is attempted to be activated but is disabled. This will provide an alert that an unsuccessful access has been attempted via the Remote Release.

Failed Entry Attempt

Will activate relay if any unsuccessful Use Code entry occurs. This will provide an alert that an unauthorized Use Code entry has been detected.

Disabled User Entered Code

Will activate relay if a User enters their User Code while that User Code is disabled. Provides an alert that a disabled Use Code entry has been detected.

Authorized Entry

Will activate relay anytime a User enters a valid User Code and is granted access.

Scheduled (Group 1 Activated)

Will activate relay if the lock has been programmed for Scheduled Relay Activation (Group 1 Initiated) and a member of Group 1 has entered their User Code within the required window.

Locked by Schedule

Will activate relay if the lock has been locked by a programmed schedule.

Unlocked by Schedule

Will activate relay if the lock has been unlocked by a programmed schedule.

Lockout # of Attempts Exceeded

Will activate relay if the number of User Code entry attempts has been exceeded and the keypad is locked out.

Ambush Function Activated

Will activate relay if the Ambush Code is entered followed by a valid User Code.

Any Keypress of Card Entry

Will activate relay any time a key is pressed or a proximity card is presented

Relay follows Lock/Unlock Status

Relay will activate when lock is unlocked. Relay power must be provided from an external power supply. If **Relay follows Lock/Unlock Status** is selected, the relay will remain activated as long as the door is unlocked. This feature supersedes all other relay options.

Activate Relay on Door Ajar

For use with the DL/PDL3300 lock. Relay will activate when Door is found to be ajar, that is, left open after a specified period of time (see the Options tab on previous page). If **Activate Relay On Door Ajar** is selected, the relay will remain activated for as long as a valid door ajar trip is in effect.

"Programmable Features" Screen - Remote tab

This screen is used to program Remote Input Functions. **Note: Remote Disabled Lock, Forced Lock Follows Remote or Forced Unlock Follows Remote** should only be used with external power to the lock.

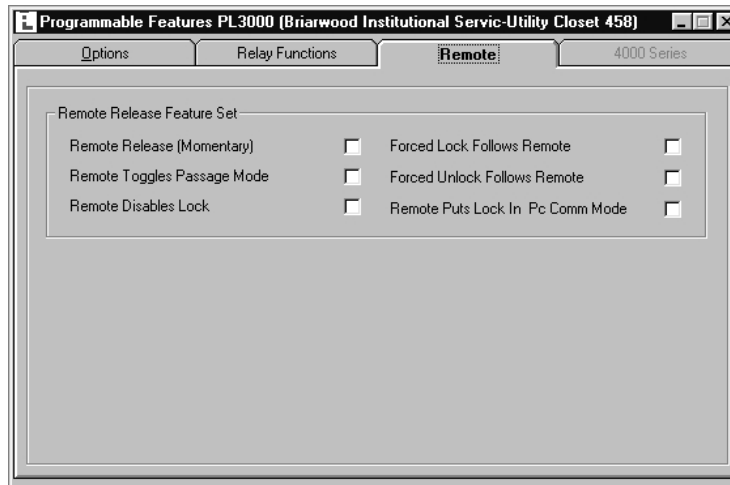

Select one of the Remote Input Functions below.

Remote Release (Momentary)

Remote input is enabled and will cause the door to momentarily unlock.

Forced Lock Follows Remote

Checking this box will cause the lock to lock when a short is maintained across the remote input. The lock will remain locked until the next User Code entry, at which time the lock will return to Passage Mode.

Remote Toggles Passage Mode

If enabled, the remote input will toggle Passage Mode. Passage Mode allows passage through the door without the need for a User Code.

Forced Unlock Follows Remote

Checking this box will cause the lock to unlock when a short is maintained across the remote input. The lock will remain unlocked until the next User Code entry, at which time the lock will lock.

Remote Disables Lock

Remote input disables the lock while a short is maintained across remote input. Therefore, if a switch is used for the remote input, as long as the switch is closed the lock will be disabled and its state cannot be changed. As long as the switch is open, the lock will be enabled.

Remote Puts Lock in PC Comm Mode

For use with DL-WINDOWS software. The remote input will act as User 298 or keypad Function 58. See page 8 for details regarding keypad Function 58.

"Programmable Features" Screen - 4000 Series tab

These screens are used to program the Residency/Privacy options and features for the 4000 Series locks. The screens below display the DL-Windows screen defaults (which also reflect the "out of box" factory default programming). Shown below (left) a PDL4100 ("Privacy") lock and (right) a PDL4500 ("Residency") lock. **Note:** DL locks do not provide PROX access, therefore the DL lock screens do not reference PROX options.

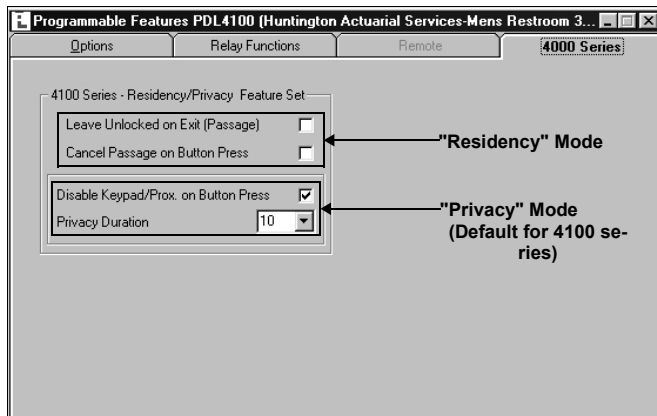

4100 Series Locks

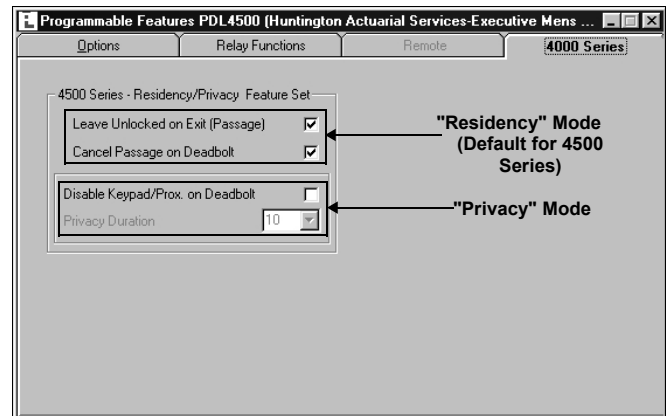

4500 Series Locks

PDL4100/DL4100 & PDL4500/DL4500 Privacy and Residency Features

The **4100** series locks leave the factory as "Privacy" locks, with the below "Privacy Mode" as the default program. If you wish, 4100 series locks can be re-programmed as "Residency" locks (see below, "Residency Mode"). The following provides basic descriptions of the two modes. For more information, see WI1194 and/or WI1195.

The **4500** series locks leave the factory as "Residency" locks, with the below "Residency Mode" as the default program. If you wish, 4500 series locks can be re-programmed as "Privacy" locks (see below, "Privacy Mode"). The following provides basic descriptions of the two modes. For more information, see WI1194 and/or WI1195.

Note: Only PDL series locks provide PROX access. Although the below descriptions apply to PDL series locks, these descriptions can also apply to DL series locks, however all references to PROX features should be ignored. In addition, the 4100 series locks have a *button* on the exterior/outside of the locks, and the 4500 series locks have a *deadbolt knob*.

Privacy Mode (Factory Default for 4100 Series Locks):

"Privacy Mode" is designed to allow access to individuals with access codes (or PROX cards) and is typically used for rooms needing privacy from others such as bathrooms, dorms and meeting rooms.

"Privacy Mode" initially provides a normally locked state. To enter, the user must use a User Code, key, or present a PROX card. Once inside, the user presses the button (on 4100 series) or throws a deadbolt (on 4500 series) that disables the keypad (and PROX card reader), disallowing others to enter for a fixed amount of time ("Privacy Duration"). The red LED on the exterior/outside of the lock will blink—indicating the room is occupied. When the initial user exits, the 4100 series lock reverts back to its originally locked mode, again allowing access to any authorized users.

The Privacy Duration for the 4100 series lock can be programmed to disable User Code and PROX card access for up to 250 minutes. When active, all User Numbers 12 and higher are disabled, and User Numbers 1 - 11 (or a key) can always override this lockout feature by entering their User Codes and/or PROX cards. **Programming:** As shown in the images above, check "Disable Keypad/Prox on Button Press (or Deadbolt)" and select a **Privacy Duration** (default is 10 minutes, valid entries 001-250).

Residency Mode (Factory Default for 4500 Series Locks):

The "Residency Feature" is provided to prevent a person from unintentionally having the door lock behind them when stepping outside briefly. Typically used in retirement homes and college dormitories.

"Residency Mode" initially provides a normally locked state. To enter, the user must use a User Code, key, or present a PROX card. The 4100 series lock will then re-lock when door is closed. However, *turning the handle and exiting from the inside* will unlock the 4100 series lock and set it to an unlocked state.

Any of the following will restore the lock to its normally locked state: (1) the user returns, enters, and presses the button (or throws the deadbolt) from the inside; (2) someone already inside the premises presses the button (or throws the deadbolt); (3) pre-programmed scheduling; (4) entering a valid User Code, presenting a valid PROX card, or locking with a key. **Programming:** As shown in the images above, check "Cancel Passage on Button Press (or Deadbolt)", and "Leave Unlocked on Exit (Passage)".

"Schedule-TimeZone" Screen - TimeZones Area

This screen consists of two parts--the **TimeZones** area (top) and the **Schedule Entry** area (bottom). The TimeZones area is used to program the time the event(s) will occur, and the Schedule Entry area is used to create events that can be linked to the times created in the TimeZones area. This page will focus on the TimeZones area. See next page for the Schedule Entry area.

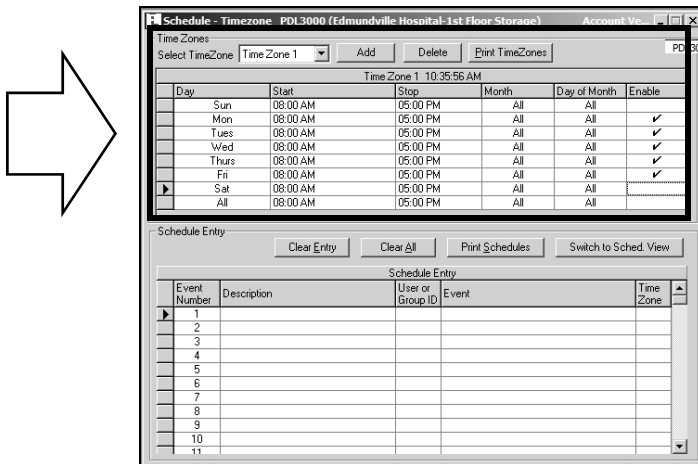

Quick Tip: Days of the Week
RIGHT click on the Enable Column, select which day(s) to enable

Enable All Week
Enable Sat-Sun
Enable M->F
Enable M-W-F
Enable T-TH
Disable All

from the following:
LEFT click to select desired day(s).

Note: Open-ended TimeZones can be entered by creating (or modifying) a TimeZone and leaving the stop time blank. This would also suppress any other events for that TimeZone. For example, your regular schedule is Mon-Fri 8-5 but one of those days is a holiday. Another TimeZone could be created with the end time removed for the holiday. That TimeZone would be used in conjunction with a LOCK event and that door would stay locked for that TimeZone duration.

TimeZone

Select TimeZone: Use the Selector to select the desired Time Zone. 250 maximum allowed.

Add

Add TimeZone. Click the Add Button, the Select Time Zone drop-down (described above) will show the additional Time Zone selection option. If the only Time Zone available was TimeZone 1, you will now see an option for TimeZone 2. 250 maximum allowed.

Delete

Delete TimeZone: If it becomes necessary to remove a TimeZone, first select the TimeZone by clicking on it in the Select Time Zone window. When selected, remove the TimeZone by clicking Delete.

Day

The **Day** column cannot be altered. Select the day by clicking the day desired under the **Enable** column.

Start

This is the time that the TimeZone will begin for the day selected. To select a Start time, click the mouse cursor in the Start cell for the desired day. Highlight the entire cell to completely re-type start time, or just highlight the section to be altered and then type in the new value.

Stop

This is the time that the Time Zone will stop for the day selected. To select a Stop Time, click the mouse in the Start cell for the desired Day of the week. Highlight the entire cell to completely re-enter start time, or just highlight the section to be altered and then type in the new value.

Quick Tip: Copy Start Times
Highlight the Start Time that is to be copied to all other Start Times, then click the RIGHT mouse button, the following will appear:

Set All As Current Start

LEFT click to select. All Start times will now be set to the copied Start Time.

Quick Tip: Copy Stop Times

Highlight the Stop Time that is to be copied to all other Stop Times, then click the RIGHT mouse button, the following will appear:



LEFT click to select.
All Stop Times should now be set to the copied Stop Time.

Month All, January - December

TimeZones can be set for all 12 months of the year (Default=All), or for specific months. To select, click mouse in **Month** cell, from the drop-down menu select the desired month.

Day of Month All, 1-31

TimeZones can be set for specific days of the month (Default=All). To select, click mouse in **Day of Month** cell, and from the drop-down list select the desired day.

- If a specific month AND day is selected, then the TimeZone will be set to occur on *only this specific day* in the month chosen.
- If the **Month** field is set to All, and a **Day of Month** is selected, then the TimeZone will be set to occur *only on this specific day every month of the year*.

Enable

Double-click on the day(s) desired. If the day is enabled, a ✓ will appear under the Enable column.

Print Schedules

At any time, all programmed TimeZones can be printed by clicking on the Print Schedules button.

Switch to Sched. View

Combines the times programmed in the **TimeZone** area with the events programmed in the **Schedule Entry** area of the **Schedule-TimeZone** screen. Results are displayed in the **Schedule View** screen.

NOTE: The **Schedule-TimeZone** screen is "Global"--when a new TimeZone is created, *it can be used for all locks in an Account*.

"Schedule-TimeZone" Screen - *Schedule Entry Area*

This screen consists of two parts--the **TimeZones** area (top) and the **Schedule Entry** area (bottom). TimeZones area is used to program the time the event(s) will occur, and the Schedule Entry area is used to create events that can be linked to the times created in the TimeZones area. This page will focus on the Schedule Entry area. See previous page for the TimeZones area.

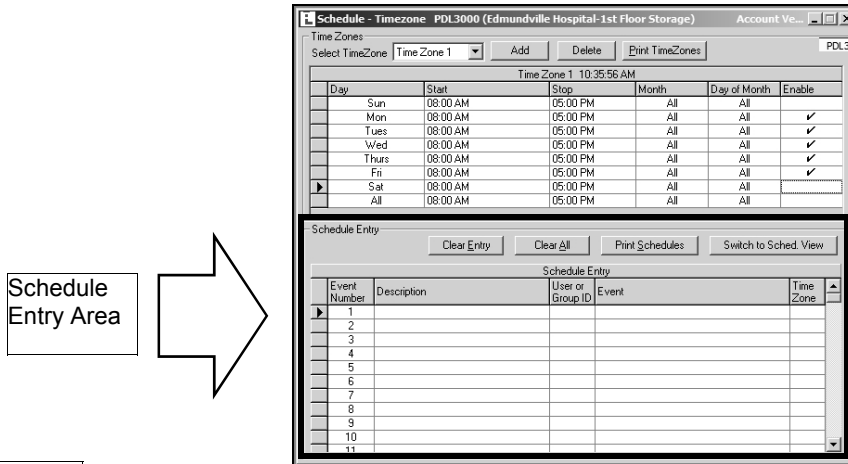

Event Number

An Event Number is assigned to each scheduled event. Up to 500 events can be scheduled for the DL3500 and PDL3000 locks, and 150 events for the DL3000. This number is displayed for reference only.

Description

Any text description of each scheduled event can be entered. Up to 30 characters are allowed. Displayed for reference only.

User or Group ID

This is the Group or User Number associated with the scheduled event. If the event is associated with a Group, valid entries are 1 to 4. If the event is associated with a User Number, valid entries are 2 to 2000 (for the PDL3000).

Note: When adding data to the "User or Group ID", "Event" and "TimeZone" columns, all three columns must be completed at one time. For example, if data is selected in only two columns for one event, and the third column is left blank, all information for the event will be automatically deleted.

Event

These are the events which will affect the associated Groups or Users at the time and the duration specified in the **Schedule-TimeZone** screen.

The events are:

- (Blank)
- Unlock
- Lock
- Disable Group
- Enable Group
- Disable User
- Enable User
- Passage Mode by Grp1-Open Window
- Relay Activation by Grp1-Open Window
- Enable Group 4 by Grp1-Open Window

Note: When adding data to the "User or Group ID", "Event" and "TimeZone" columns, all three columns must be completed at one time. For example, if data is selected in only two columns for one event, and the third column is left blank, all information for the event will be automatically deleted.

TimeZone

Click in the cell and use the drop-down menu to select the TimeZone number you wish linked to the schedule entered.

Note: When adding data to the "User or Group ID", "Event" and "TimeZone" columns, all three columns must be completed at one time. For example, if data is selected in only two columns for one event, and the third column is left blank, all information for the event will be automatically deleted.

Clear Entry

To clear all items programmed, highlight the line to be cleared (click on the column to the left of the **Event Number** column), and then click **Clear Entry**.

Clear All

Clears all scheduled entries.

Print Schedules

At any time, all programmed schedules can be printed by clicking on **Print Schedules**.

Switch to Sched. View

Combines the times programmed in the **TimeZone** area with the events programmed in the **Schedule Entry** area of the **Schedule-TimeZone** screen. Results are displayed in the **Schedule View** screen.

"Schedule View" Screen - Program Field Definitions

The **Schedule View** screen combines the times created in the **Schedule-TimeZone** screen. The **Schedule View** screen displays schedules (with their event time information) listed in separate rows. In addition, schedules received from locks are viewed only in the Schedule View screen.

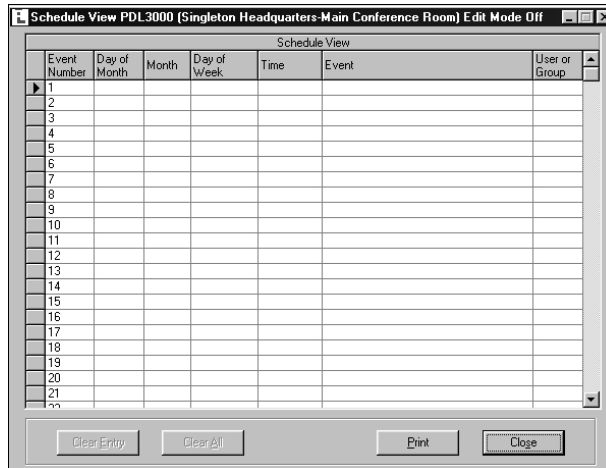

Notes on the Schedule View screen

The **Schedule View** screen is defaulted as a read-only screen. Editing events from this screen is not recommended.

Note: If a lock with a program created through keypad programming is uploaded, it can only be viewed or altered through the **Schedule View** screen, not the **Schedule-TimeZone** screen. Before any downloading can be performed from the **Schedule View** screen, select **Send Schedule from Schedule View** option in the **Options** dialog.

Event Number

An Event Number is assigned to each scheduled event. This number is displayed for reference only.

Day of Month

This is the Day of the Month enabled in the **TimeZone** area of the **Schedule-TimeZone** screen.

Month

This is the Month entered in the **TimeZone** area of the **Schedule-TimeZone** screen.

Day of Week

This is the Day of the Week entered in the **TimeZone** area of the **Schedule-TimeZone** screen.

Time

This is the time entered in the **TimeZone** area of the **Schedule-TimeZone** screen.

Event

This is the Event entered in the **Schedule Entry** area of the **Schedule-TimeZone** screen.

User or Group

This is the User or Group that was entered in the **Schedule Entry** area of the **Schedule-TimeZone** screen.

An **Unlock** Schedule Entry using a **Start & Stop** Time Zone will create a START Unlock and STOP Lock time in the Schedule View.

Creating Schedules is a 2 step process:

Step 1: First set the time the event will occur in the TimeZones section of the **Schedule-TimeZone** screen.

Step 2: Select the scheduled events in the Schedule Entry area of the **Schedule-TimeZone** screen.

TimeZones are typically based on shifts, regular business hours or other similar requirements. These TimeZones will be used to enable/disable Users by individual User or Groups of Users in the Schedule Time screen. By default, DL-Windows creates a default TimeZone which selects all 7 days of the week, from 8:00 AM to 5:00 PM.

Clear Entry

Available only if *Read Only in Schedule View* is disabled

To clear all items programmed, highlight the line to be cleared (click on the column to the left of the **Event Number** column), and then click **Clear Entry**.

Clear All

Available only if *Read Only in Schedule View* is disabled

Clears all scheduled entries.

Print

At any time, all programmed Schedules can be printed by clicking **Print**.

Close

Click to close the **Schedule View** screen.

"Options" Screen - Program Field Definitions

The **Options** screen allows you to select Account and DL-Windows preferences.

The screenshot shows the 'Options' dialog box with the following sections:

- Administrative Options:** Send Schedule from Schedule View
- Global Ambush Code:** Set Global Ambush Code (2 Digits All Locks). Use AmbushCode. Value: 99
- Language Support:** Select Language: English
- Working Directory:** Current Selected Path: C:\DAVID BLOCK\NEWIN\PROGRAM\ Set Working Directory
- Options:** Open Event Log Viewer on Receive, Show Global User ID's
- StartUp Screens:** Schedule Entry, Schedule View, Event Log Viewer, Features
- Select the Grid Colors for all Grids:** Set Header Backcolor, Set Header Text Color, Set Grid Backcolor, Set Grid Text Color, Rest Grid to Default Colors

Send Schedule from Schedule View (supervisory)

When schedules are received from locks into DL-Windows, they can only be viewed in the **Schedule View** screen. Because edits can be made directly in the **Schedule View** screen (see above, "Disable Editing in Schedule View (supervisory)"), it is convenient to send Schedule information directly from the **Schedule View** screen back to the lock directly. To allow the ability to update the lock from the **Schedule View** screen, check this box. To enable password, select Options, Password Setup, Supervisor Password.

Global Ambush Code

A 2 digit code which will activate the auxiliary relay if entered before a valid User Code, and is the same for all locks in the Account. You must also select **Ambush** from the Relay Function List. Uncheck the box to disable the Ambush code (as shown).

Language Support

Select the language that will populate all DL-Windows screens from the drop-down list.

Working Directory

Select the directory in which all DL-Windows files will reside.

Open Event Log Viewer on Receive

When checked, allows the Event Log Viewer screen to open automatically after receiving data from a lock

Show Global User ID's

The Global User ID number can be hidden from view. A Global User ID is used within the Global Users screen and simply lists all potential Users within an Account. DL-Windows keeps track of each "Global User" listed in the Global Users screen by use of the Global ID number. The number acts as an internal designation only.

StartUp Screens

Selected screens will automatically open upon double-clicking a selected lock in the Account Tree field.

Select the Grid Colors for all Grids

Allows you to personalize the colors of grids and header background "backcolors" and the accompanying text. Click **Reset Grid to Default Colors** to change the selected colors back to their default factory settings.

Exporting and Importing Data

Exporting Data

Tools > Export Active Account to CSV

This feature exports all User data from a DL-Windows Account and saves the data to a .CSV (comma separated values file) file. The .CSV file can then be imported into another Account using DL-Windows.

Click **Tools, Export Active Account to CSV** on the menu toolbar to export data. For each .CSV file, each line in the file is one entry, and the fields in each entry are separated by commas. Exported .CSV files will be placed in the C:\DL-Windows\Export folder. When the Account has been converted to a .CSV file, the following popup appears:



Note: Two Files will be placed in the Export directory:

- **Acct3.csv** - The exported file, in a comma delimited format.
- **Acct3.log** - The error log file. If populated, this file will reference the line number of the error in the .CSV file.

The file size of these Accounts will typically be larger than what a 1.44 MB floppy disc will hold. A ZIP Drive, memory stick or network drive is advised for transferring exported files. It may be possible to WinZip each file and place it on a floppy disc one file at a time, but that depends on the size of the Account.

Importing Data

The **Tools > Import CSV File** menu contains two import utilities to allow you to combine Users from one Account with another Account.

Before using either Import utility, first open the Account to which the data will be imported. If the Account does not yet exist, a new "test" Account can be created if desired. Next, transfer the files to the computer where the Accounts are to be restored and place the files in the DL-Windows Import directory (typically C:\DL-Windows\Import).

Tools > Import CSV File > Import CSV File From DL-Windows

This feature imports a .CSV file (comma separated values file) created by the **DL-Windows Export Active Account to CSV** menu option (see "Exporting Data" above).

Note: If any Users exported are not wanted, you can open this file in Excel and delete the unwanted entries (always delete the entire line and not part of a line).

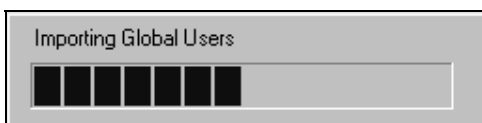

Tools > Import CSV File > Import CSV File From Excel

This menu selection allows you to import a .CSV file that was created in MS Excel and saved as a .CSV file. To create the Excel file, open Excel and populate each cell as follows:

- Cell A1** = First Name
- Cell B1** = Last name
- Cell C1** = Address
- Cell D1** = City
- Cell E1** = State
- Cell F1** = Zip Code
- Cell G1** = Telephone
- Cell H1** = Social Security Number

To export the file from Excel as a comma separated values file, click **File, Save As...**, then in the **Save as type:** pull-down menu select **CSV (MS-DOS) (*.csv)**. **Note:** Unused cells must be left blank.

Transferring Account Files Between PC's

We recommend using a USB drive flash memory card when transferring DL-Windows Account files from one computer to another. To ensure a successful transfer, both computers must correctly operate with USB drive flash memory cards before performing this procedure. DL-Windows must not be running on either system. **Note:** The **Tools, Import a Single ADF Account File** menu feature used in the procedure below is only supported by DL-Windows versions 3.5.5 and greater.

Account files exist in pairs:

- **Acctx.Adf** is the Account file
- **Acctx_Log.adf** is the Event Log for the Account file

In the example that follows, the names **Acct2.adf** and **Acct2_Log.adf** are used. Note that some Windows systems are not configured to display file extensions (you may only see **Acct2** and **Acct2_Log** -- this is OK. Please proceed as if the file extensions are displayed).

At the source computer (from which you want to transfer the DL-Windows Accounts), open **Windows Explorer** from the **Start, Programs** menu. Locate the DL-Windows installation folder (if you selected the default folders, look in "C:\DL-Windows").

Highlight the Account files you wish to transfer (hold down the "Ctrl" key and click on each file). Right-click the highlighted files and click **Copy** (see image below).

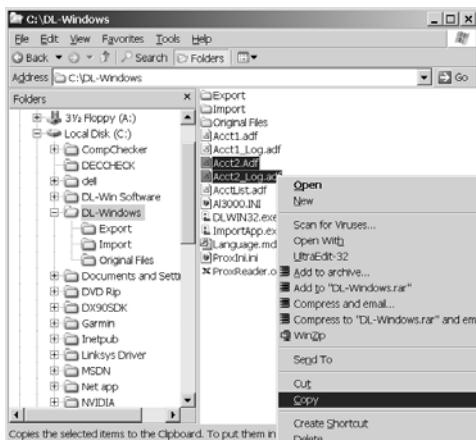

Locate your USB drive in the left hand pane of the **Windows Explorer** window. Click to select the USB drive, then right-click in the right hand pane and click **Paste** (see image below).

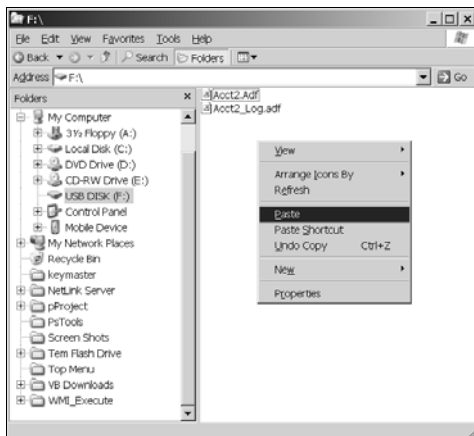

Remove the USB drive from the source computer and connect it to the target computer. Similar to the previous steps, at the target computer, open **Windows Explorer** and locate the USB drive. Highlight the Account files to transfer, right-click and select **Copy**. Locate and click to highlight the DL-Windows folder. Right-click in the right hand pane and click **Paste**.

Launch DL-Windows. Click **Tools, Import a Single ADF Account File** (see the image below). **Note:** The word "Single" in the menu refers to both Account files that were copied.

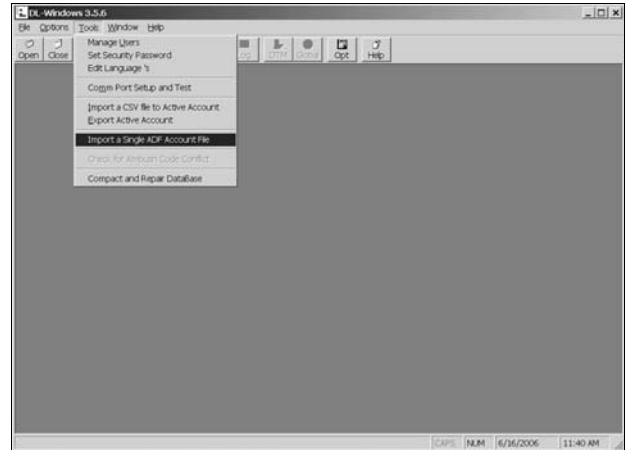

Click **Yes** to the import question and an **Open** file dialog box appears:



Although both files that were copied appear, only select the **Acct2.adf** file and click **Open**. The **Name Account** dialog appears (see below image) requesting a new name be created for this new Account.

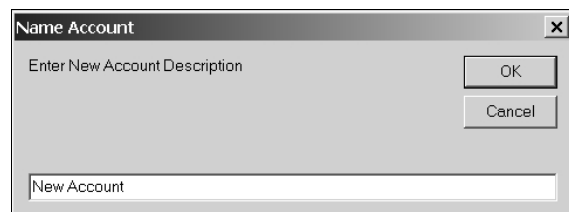

Click **OK** to complete the import process.

"DTM 3 Support" Screen - Program Field Definitions

The **DTM Support** screen is used to configure an AL-DTM to transfer data to or from multiple locks.

Quick Tips:

RIGHT click on the **DTM Function** column, and select desired action:

Change All Receive Log
 Change All Send Program to Lock
 Change All Receive Program from Lock
 Change All "Receive Log" if Selected
 Change All "Send Program to Lock" if Selected
 Change All "Receive Program from Lock" if Selected

RIGHT click on the **Selected** column, select desired action.

Select All
 UnSelect All
 Invert Selection

Note:

For every new lock that is added, the DTM screen will automatically use the next available Door Number in the selected DTM Configuration. For example, in the screen image at left, the next lock that will be added (for "DTM Config 1") will be Door Number 2.

In addition, if you select **Clear DTM Config** while in "DTM Config 1", all locks will automatically be reloaded to their default door number. If you have existing DTM configurations and locks assigned to these locations, the system **WILL NOT OVERWRITE** them, unless you select "DTM Clear All". All other configurations are left alone and not handled in this manner.

DTM Config

Press drop-down menu to select and display DTM Configuration.

Add DTM Config

Click to add additional DTM configurations.

Clear DTM Config

Click to clear the selected DTM configurations.

Delete DTM Config

Click to delete the selected DTM configurations.

LockID

Identification of each door with a specific number. The LockID is used to identify the lock to the DTM, ensuring that the correct programming is matched to the correct lock. No longer entered through AL-59. See also Glossary entry "LockID").

Lock Name

Displays the name used when the lock was first entered in the DL-Windows Account.

Master Code (Display only)

Displays the Master User Code of the lock that was initially programmed in the **Global Users** screen. This Master Code must match the Master Code programmed in the lock. **Note:** This field is for display only.

DTM Function

Select which of the following functions the DTM will perform when communicating with the lock:

Receive Program from Lock
 Send Program to Lock
 Receive Log

Selected

If checked, DL-Windows will configure the DTM for the operation programmed or transfer data for the locks selected. To enable, double-click in the **Select** column for the Door Number desired, and a ✓ will appear.

Send All Locks To DTM

Click to send all lock configurations to the DTM.

Send Selected Locks To DTM

Click to send only those selected lock configurations to the DTM. (A check (✓) appears in the **Selected** column for all selected lock configurations).

Transfer All Locks From DTM

Use this button after the AL-DTM had valid data loaded from the lock. Data will be received from all locks that have been selected in the **DTM Support** screen.

Transfer Selected Locks From DTM

The DTM Support screen will receive data from only those locks that have been selected (A check appears in the **Selected** column).

Set Lock Clock

If selected, the software will reset the lock's clock each time data is transferred.

Data Retention Time

The AL-DTM goes into a **Power Saving Mode** after 10 minutes of no activity. The AL-DTM will remove all power after the time specified in this field. Although all AL-DTM data will be lost after a power down, this will only affect *Send Program to Lock*, *not Receive Log* or *Receive Program* configurations. Possible selections are: **Forever, 1 Day, 7 Days** or **40 Days**.

Baudrate

The Baudrate specifies the rate at which bits are transmitted from (or to) the AL-DTM. Selections are in bits per second. DL-Windows can be configured to communicate at baudrates between 9600 and 57600 bits per second. The Baudrate selection field is only used with the AL-DTM and can be lowered in case of communication trouble. **Note:** Some USB Adapters do not support all baud rates.

AL-DTM Specifications



AL-DTM - Data Transfer Module

Data Transfer Modules allow the transfer of lock programs and other data between DL-Windows software and Alarm Lock locking devices. Currently, the latest software inside Alarm Lock's Data Transfer Modules is *AL-DTM-III*, and this version software (or later) is used exclusively with DL-Windows 3.5.X (or later). Previous versions of DTM software exist; the oldest *AL-DTM* version is no longer supported, and the *AL-DTM-II* version must be upgraded and/or configured for *AL-DTM-III* operation (see WI1428 for upgrade instructions, or WI1443 for *AL-DTM-III* configuration instructions).

The improved *AL-DTM-III* software allows for more locks to be stored per account, both within DL-Windows and within the *AL-DTM-III* itself.

AL-DTM-III Features

- **Expanded Memory Capabilities**
 - Allows for accounts of up to 2000 doors
 - Can hold up to 200 *PDL3000* / *PDL3500* model locks, or up to 1000 *DL3000* / *DL2800* model locks.
 - Receive Event Logs of up to 5000 lock events.
 - Full programming support--Send/Receive all 2000 Users for PDL series locks.
- **Foreign Language Support***
- **Door Select Feature*** - The need to program a door number into the lock--before *AL-DTM/Lock* communication--is no longer required. Simply select the door number on the *AL-DTM* and proceed with the transfer. (The *AL-DTM* cannot change door numbers).
- **"Cold Start" Capability*** - Clear all data from memory without removing the battery.

* See page 25 for *AL-DTM* configuration options.

AL-DTM Basic Modes of Operation

1. **PC-COMM Mode**
(DL-Windows/*AL-DTM* Communications)
 - Transfer multiple lock programs from DL-Windows to *AL-DTM*
 - Receive multiple lock logs or lock programs stored in the *AL-DTM* back to DL-Windows
2. **LOCK Mode**
(*AL-DTM/Lock* Communications)
 - Transfer lock program from the *AL-DTM* to a specific lock
 - Receive specific lock log or program from the lock back to the *AL-DTM*

Note: Transferring Event Logs (from the *AL-DTM* or DL-Windows to the lock) is not possible. Event Log data is *read only*.

AL-DTM Specifications

Power Requirements:	(1) 9 Volt Alkaline Battery--Duracell MN1604 or equivalent
Battery Life:	Standby Mode: 60 Hours Sleep Mode: 1 Year
Operating Temperature:	0 - 49°C (32-122°F)
Dimensions:	7.5" x 4" x 1.5" (H x W x D)

Compact and Repair the Database

Compact and Repair DataBase

Maintaining the DL-Windows DataBase is accomplished via the Tools menu. You can export, import and compact/repair the Account information contained in the DataBase.

Maintaining the database on a regular basis will reduce the size of the database and improve the reliability of communications between the lock and DL-Windows. Click **Tools, Compact and Repair DataBase** on the menu toolbar and the utility will immediately begin to function.

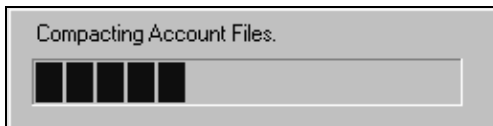

While the DataBase is compacting/repairing, the above indication notification appears, followed by the below popup when the utility is complete.

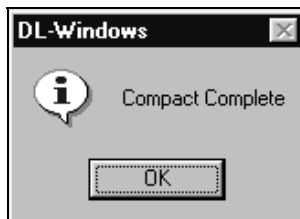

If database errors occur within Accounts, click **Tools, Compact and Repair**.

Foreign Language Support

Changing the Default Language

On the toolbar, click **Opt** and the **Options** dialog opens (see below). Additional languages are available in the **Select Language** drop-down menu. Select the desired language.

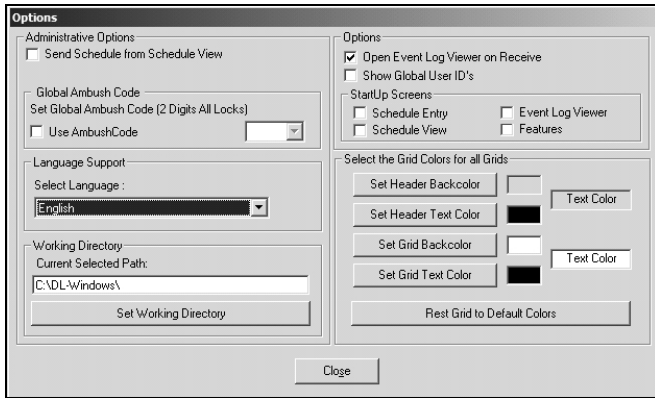

You must close and restart DL-Windows for the language changes to take effect (press OK to close the popup, shown below).

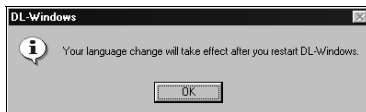

DL-Windows will now display in the new language (Italian in the below example).

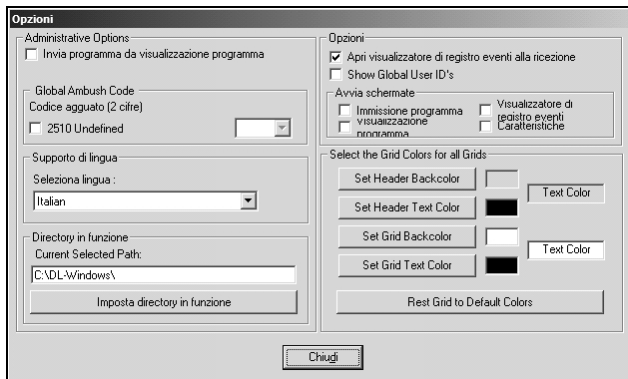

Editing an Existing Language

From the toolbar click **Tools, Edit Language's**. The **Language Translation** screen will appear.

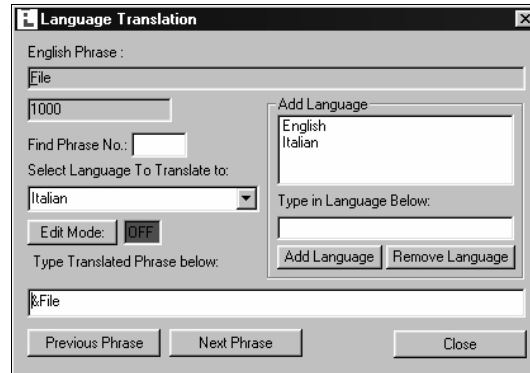

Note:
English cannot be Edited.

Edit an existing language by selecting the language from the drop-down menu. Click **Edit Mode** and the text field will change from RED to GREEN and read "ON". The languages available in the example shown above are English and Italian. The phrases to be translated are numbered starting at 1000.

To find and edit a specific phrase, type the phrase number into the **Find phrase No:** field and press on your keyboard.

Adding Support for a New Language

In the **Language Translation** dialog (below), **Edit Mode** must be set to **ON** in order to add a new language. Enter the name of the new language into the **Type in Language Below** field and click **Add Language**.



Advanced Programming

Programming Schedules with Suppression

Follow the steps below to download a schedule with *suppression* (an exception that "suppresses" the general rule).

1. Enter the time for which the event is to be scheduled in the top (the **TimeZones** area) of the **Schedule-TimeZone** screen. In the example below, a general daily unlock event is programmed to occur every Monday - Friday from 8:00 AM to 5:00 PM ("TimeZone 1").

The screenshot shows the 'Schedule Entry' window with 'Time Zone 1' selected. The top table lists days from Sun to All with start and stop times (08:00 AM to 05:00 PM) and 'All' for both Month and Day of Month. The bottom table shows a single event: Event Number 1, Description 'Daily Unlock', User or Group ID, Event 'UnLock', and Time Zone 1.

2. Now add a second **TimeZone** to create an exception to the first general unlock event, adding the days when the lock should remain locked. In the example shown below, the lock will remain locked on the 4th of July. Click the Select TimeZone pull-down menu and select "TimeZone 2". Then click within the **Month** and the **Day of Month** fields, and select from the drop-down boxes in each field to change.

The screenshot shows the 'Schedule Entry' window with 'Time Zone 2' selected. The top table shows 'All' for days, start/stop times, and 'July' for Month and '4' for Day of Month. The bottom table shows two events: Event 1 (Daily Unlock, UnLock, Time Zone 1) and Event 2 (July 4th Exception, Lock, Time Zone 2).

This close-up shows the 'Month' drop-down menu with 'July' selected. The 'Day of Month' field also shows '4' selected.

In this example, click in the **Month** field and select the month from its drop-down list.

3. In the lower part of the **Schedule-TimeZone** screen (the **Schedule Entry** area) add the daily unlock event in **Time Zone 1** by clicking in the first row and the TimeZone column. Select TimeZone number 1 from the drop-down list. Finally, add the *suppression* for July 4th in **Time Zone 2**.

The screenshot shows the 'Schedule Entry' window with a callout box pointing to the 'Time Zone' column of the event list. The callout text says: 'Click your mouse in the field and select from the drop-down list'.

4. (Optional) Click **Switch to Schedule View** to view the schedule. If pre-existing events or schedules were programmed, a warning popup will appear.

The dialog box 'DL-Windows' contains the text: 'Are you sure you want to open Schedule View ? All Previous Data Will be Overwritten.' with 'Yes' and 'No' buttons.

Click **Yes** and the **Schedule View** screen appears.

The screenshot shows the 'Schedule View' window for 'Edmundville Hospital - 1st Floor Storage'. It displays a grid of events with columns for Event Number, Day of Month, Month, Day of Week, Time, Event, and User or Group. The events listed are: 1 (All, All, Mon-Fri, 08:00 AM, UnLock), 2 (All, All, Mon-Fri, 05:00 PM, Lock), and 3 (04, Jul, All, 08:00 AM, Lock).

Advanced Programming--Group 1 Activated Events

It is convenient for large numbers of similar Users to be grouped together. Placing Users into Groups (by assigning them specific User Numbers) allows large numbers of Users to be controlled all at once rather than individually--saving time. In the following examples, Users who are members of Group 1 are allowed to activate special lock features or other Groups of Users.

Group 1 Member Activates a Relay

This feature allows for a "window of time" to be created where if any Group 1 User Code is entered within the programmed "window", a relay will be activated for 2 seconds. This relay can be used with a burglar alarm control panel that has a key switch disarm option. If a Group 1 User does not enter their User Code during the specified "window", this feature remains inactive. This feature corresponds to keypad programming Functions 90 and 91.

Note: The alarm panel will have to be armed at night by the User or by an automatic schedule function of the alarm panel.

1. Connect terminals 5 & 6 (blue/yellow wires) to a burglar control panel with switch input for disarming.
2. Program a User that is a member of Group 1.
3. Program the Relay (Group 1 Activated) as a Relay Function in the **Programmable Features** window. Click **Feat** on the DL-Windows toolbar and select the **Relay Functions** tab. Check the box marked **Scheduled (Group 1 Activated)**.



4. Using the **Schedule-TimeZone** screen (below), in the Schedule Entry area, select **Relay Activation by Grp1-Open Window** in the **Event** column. If any Group 1 User Code is entered during the programmed "window", the relay will close for 2 seconds. **Note:** Only 1 relay closure will occur--even if a second Group 1 User Code is entered.

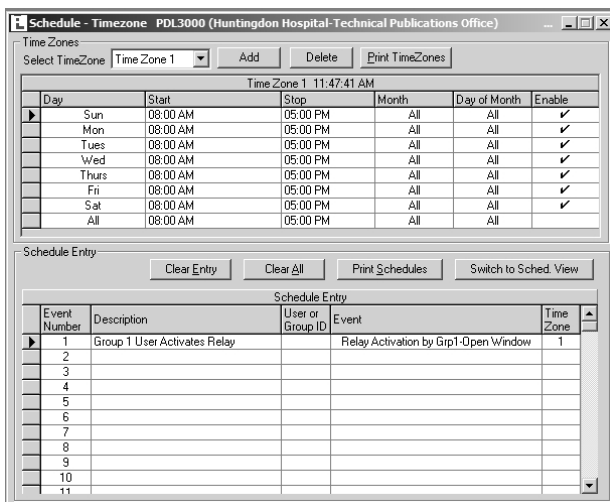

5. Create the "Relay Activation window" in the **TimeZones** area of the **Schedule-TimeZone** screen (above). In this example, program a "window" at 8:30AM to 10:00AM, Monday to Friday. The relay will close, one time only, when a member of group 1 enters their User Code between 8:30AM and 10:00AM.

6. Click **Switch to Sched. View**

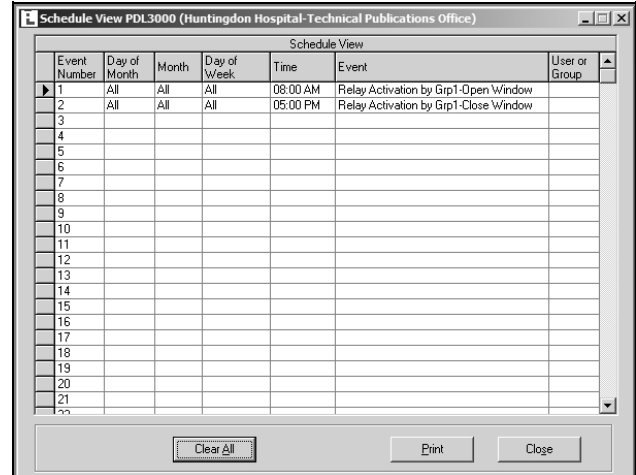

Other Group 1 Activated Events

Like the previous example, other Group events can be programmed in a similar manner. Here are two examples:

Group 1 User Enables Group 4 Users

Note: This feature corresponds to keypad programming Functions 92 and 93.

1. Using the **Schedule-TimeZone** screen, in the Schedule Entry area, select **Enable Group 4 by Grp1-Open Window** in the **Event** column. Next, create the "Enable Group 4 window" in the **TimeZones** area of the **Schedule-TimeZone** screen. This will allow any Group 1 User to enable Group 4 Users, if a Group 1 User Code is entered within this programmed "window".
2. Program a Group 1 User and a Group 4 User.

"Window" Example: Open window at 7:00AM and 8:30AM. Group 4 will be enabled when a User in Group 1 enters their User Code between 7:00AM and 8:30AM. Group 4 Users will have to wait outside the lock until a Group 1 User arrives to enable their User Codes. If a Group 1 User does not arrive between 7:00AM and 8:30AM, Group 4 will not be enabled.

Group 1 User puts lock in Passage Mode

Note: This feature corresponds to keypad programming Functions 88 and 89.

1. Using the **Schedule-TimeZone** screen, in the Schedule Entry area, select **Passage Mode by Grp1-Open Window** in the **Event** column. Next, create the "window" in the **TimeZones** area of the **Schedule-TimeZone** screen. The lock will unlock (enter *Passage Mode*) when any Group 1 User enters their User Code during the programmed "window".
2. Program a Group 1 User and a Group 4 User.

Note: *Passage Mode* will be maintained indefinitely unless disabled each night by using keypad Function 46 or by scheduling a lock closing.

"Window" Example: Program a "window" at 7:00AM and 8:30AM. The lock will unlock when a User in Group 1 enters their User Code between 7:00AM and 8:30AM. If no Group 1 member arrives between 7:00AM and 8:30AM to enter their User Code, the lock will stay locked all day.

Set Group and Level Assignment

To select a Group Association, open the **Global Users** screen (click the **Global** button on the menu toolbar). Click the **Set Group Assignment** button and the **Set Group Assignment for User** dialog opens:

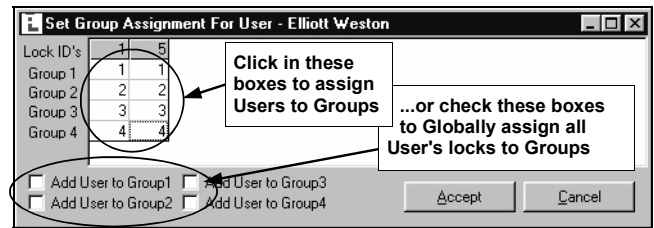

Click in the numbered boxes under the LockID numbers to assign Groups to the User, as shown. The boxes clicked will turn green, confirming the Group number status for the User. **Note:** You can also hold down the CTRL key on your keyboard and click multiple selections, as necessary. Check the **Add User to Group (X)** checkboxes to "Globally" assign all of that User's locks to Groups. When finished, open the **Lock Data** screen to verify the addition (s).

To change the Program Authority Levels (1-4) for each user, in the **Lock Data** screen (shown above) double-click in the box that intersects the Level number (column) and the User Name (row). Double-clicking adds a check mark to the box, thus defining the Program Authority Level for that User.

Name	User No.	User Code	Level 1	Level 2	Level 3	Level 4	GP1	GP2	GP3	GP4	Enable User
Master Code	1	123456	✓	✓	✓	✓					✓
Installer 1	2		✓	✓	✓	✓					
Installer 2	3		✓	✓	✓	✓					
Manager 1	4		✓	✓	✓	✓					
Manager 2	5		✓	✓	✓	✓					
Manager 3	6		✓	✓	✓	✓					
Supervisor 1	7		✓	✓	✓	✓					
Supervisor 2	8		✓	✓	✓	✓					
Supervisor 3	9		✓	✓	✓	✓					
Print Only 1	10		✓	✓	✓	✓					
Print Only 2	11		✓	✓	✓	✓					
Elliott Weston	12	454545									✓
Michael Steadman	13	787978									✓
	14										
	15										
	16										
	--										

The above screen image displays the default Level and Group settings for a newly added DL3000 lock. (Defaults are the same for a DL2800 lock).

Note: The **Set Level Assignment** button and screen both work in the same manner as the **Set Group Assignment** button and screen.

Managing Access to DL-Windows

Security Features in DL-Windows

DL-Windows provides security and protection features, restricting unauthorized persons from accessing your DL-Windows program. When starting DL-Windows, all Operators or Administrators must first Log-On to access the program. The type of access (either "Operator" or "Administrator") determines the types of tasks allowed within DL-Windows. **Note:** For non-Administrators, all Administrative functions are grayed-out within both the **Global Users** screen and the **Options** screen. The steps below can be accessed by Administrators only.

Adding Users (for access to DL-Windows)

Click **Tools, Manage Users** to open the **Manage Users** screen. In the **Manage Users** screen, click **Action, Add User** (or press CTRL+A). In the **Add User** dialog (shown below), enter a **User Name** and the **Full Name** in the fields provided (the **User Name** will appear on the Log-On screen when starting DL-Windows). Select the access level by checking either **Operator** or **Administrator** in **User Type**. The user can be disabled by simply un-checking **Enable User**. Enter a password (at least 4 characters) in the **Password** field and re-type the

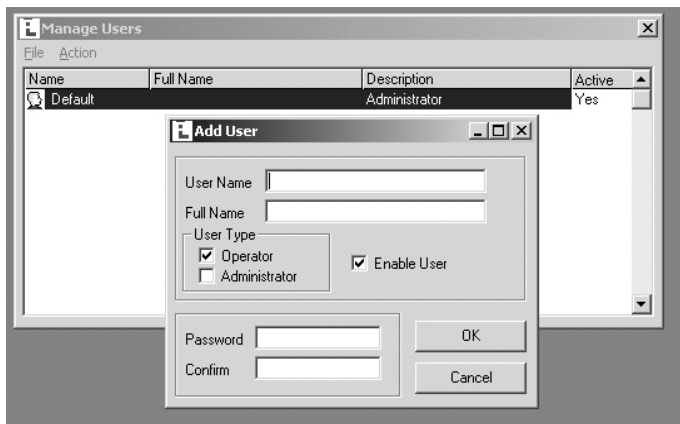

password in the **Confirm** field to verify. When finished, click **OK** to save, or click **Cancel** to discard your changes.

Editing and Deleting Users

To edit existing users, either click **Action, Edit User**, press CTRL+E, or double-click the user to open the **Edit User** dialog. All existing information can be edited, and when finished, click **OK** to save or click **Cancel** to discard your changes.

To delete an existing User, click to highlight the user in the **Manage Users** screen, click **Action, Delete User** or press CTRL+D. A confirmation popup will appear. Click **Yes** to confirm the deletion, and click **No** to retain the user.

Change Password:

To change an existing password, click to highlight the user in the **Manage Users** screen, click **Action, Set Password** (or press CTRL+P). In the **Change Password** dialog, type the existing password in the **Old Password** field, type a new password in the **New Password** field and re-type the same new password in the **Confirm** field. Press on your keyboard to accept the changes.

Function Card # 2

Initiates AL-DTM Communications (User 299)

The **AL-DTM** is used to transfer Lock Programs (and other data) between DL-Windows and PL3000 locks. When computers cannot be transported or when electrical power is not available, the hand-held **AL-DTM** acts as a go-between--it allows the transfer of lock data from your PC (through the **AL-DTM**) to the lock, or in reverse (from the lock through the **AL-DTM** back to your PC). Requires an **AL-PCI2** cable when transferring from your PC to the AL-DTM. A double-ended mini banana plug connector is used when transferring data from the AL-DTM to the PL3000 lock(s) (see page 4 for details).

Function Card #2 initiates communications. **Note:** Function Card #2 does not unlock the PL3000.

Important: All PL3000 locks arrive from the factory configured as Door #1. If the PL3000 lock data inside the AL-DTM is associated with a door number OTHER than door number 1, you **MUST** select the door number in the AL-DTM before transferring data to the lock. This will ensure that the proper data inside the AL-DTM will be matched to the correct lock. The procedure below describes this process: **Note:** The AL-DTM must be configured for Door Select Mode.

SEND PROGRAM TO LOCK (THROUGH THE AL-DTM)

1. **Send Lock Program from DL-Windows to the AL-DTM**, "Send Program to Lock" by connecting the AL-PCI2 cable (or AL-PRE) to the AL-DTM.
2. **Connect the AL-DTM to the Lock.** Connect the double-ended banana plug into the AL-DTM and into the lock that is to be programmed (observing proper tab direction).
3. **Press the Green Button on the AL-DTM** until the AL-DTM displays the following:

```
LOCK MODE
YES      NO
```

Press and release the green button (answer NO).

4. The AL-DTM will display the following:

```
DOOR SELECT MODE
YES      NO
```

Press and release the left black button (answer YES).

5. Using the black keys, change the "CURRENT DOOR" value until the door number is reached. If the door number is 8, the AL-DTM will display the following:

```
Current Door=008
<BACK NEXT> SET
```

Press and release the green button (answer SET) to lock in the desired door number.

6. The AL-DTM will display the following:

```
Ready, Door =008
GO      EXIT
```

Press the left black button (answer GO).

7. **Present Function Card #2 to the lock.** The AL-DTM will display the following:

```
Door 08,   Sending
PGM Packet 008
```

Packet Numbers will go up until all packets have been transferred to the lock. The Lock will continue to beep while in communication with the AL-DTM.

8. **At the end of the transfer process**, the PL3000 will sound a series of beeps. You can disconnect the AL-PCI2 cable. The following will display:

```
Lock's Time and
Date, Updated.
```

```
Comm. Complete,
07/24/04 02:08PM
```

(Current date and Time)

```
0993      FREE
MEMORY    BLOCKS
```

(Current Memory Status)

9. **Test New User Cards.** Verify that each new user Card allows access when presented to the lock. Test each lock that has been programmed. To receive information from the lock to the AL-DTM, see next page.

IMPORTANT NOTE:

When programming is sent from DL-Windows (or an AL-DTM) to the lock, Function Cards 1, 2, 8, and 9 will be overwritten with the existing data in DL-Windows for the User Locations 298, 299, 297 and 300, respectively. Therefore, to continue to use Function Cards 1, 2, 8 and 9 that were enrolled at startup with DL-Windows, **be sure to enroll those same Function Cards 1, 2, 8 and 9 used at startup into the correct locations within DL-Windows.**

RECEIVE PROGRAM FROM THE LOCK TO THE AL-DTM

DL-Windows must be first used to instruct the AL-DTM to "Receive Program From Lock" via the **DTM Support** screen. This way, when the AL-DTM is connected to the PL3000 lock, the AL-DTM will perform the correct operation.

1. **Connect the AL-DTM to the Lock.** Connect the double-ended banana plug into the AL-DTM and into the lock that is to be programmed (observing proper tab direction).
2. **Press the Green Button on the AL-DTM** until the AL-DTM displays the following:

```
LOCK MODE
YES      NO
```

Press the left black button (answer YES).

The AL-DTM displays the following:

```
Waiting for Lock
Power Up or Code
```

3. **Present Function Card #2 to the lock.** The AL-DTM will display the following:

```
Door 08, Receiving
PGM Packet 008
```

Packet Numbers will go up until all packets have been transferred to the AL-DTM. The Lock will continue to beep while in communication with the AL-DTM.

4. **At the end of the transfer process,** the PL3000 will sound a series of beeps. You can disconnect the AL-PCI2 cable. The following will display:

```
Lock's Time and
Date, Updated.
```

```
Comm. Complete,
07/24/04 02:28PM
```

(Current date and Time)

```
0993 FREE
MEMORY BLOCKS
```

(Current Memory Status)

SPECIAL NOTE:**WHEN USING AN AL-DTM-III**

The procedure below is required **only** when a PC or DTM communication *Function Card* is not presently enrolled in the lock; i.e. the lock is new ("out-of-box"), or the lock has had all programming erased (restoring factory default).

PC/DTM Communications

With the development of the AL-DTM-III and the latest versions of DL-Windows, communications using the AL-DTM-III requires the presentation of Function Card #2 twice. Therefore *the AL-DTM "299" Function Card #2 must be enrolled into the lock prior to using the AL-DTM-III.* **In addition, you can no longer use power up programming to establish communications with the AL-DTM-III.**

Procedure:

All lock programming **MUST** be erased to restore the "out of box" factory default, as detailed in "ERASE ALL PROGRAMMING" in the PL3000 programming instructions (WI1280). After erasing all lock programming, the PL3000 waits for a proximity card to be presented. Therefore, present a proximity card (to place the lock into "learn mode"), then immediately present the first two Function Cards (card #1 for initiating PC communications, card #2 for initiating AL-DTM communications). After cards #1 and 2 have been presented and enrolled, wait for the lock to time-out and lock.

Now the PL3000 can be programmed by the PC or the AL-DTM-III.

The **Features** screen is used to program lock options and programmable Features. For version 3.6.0, see page 33.

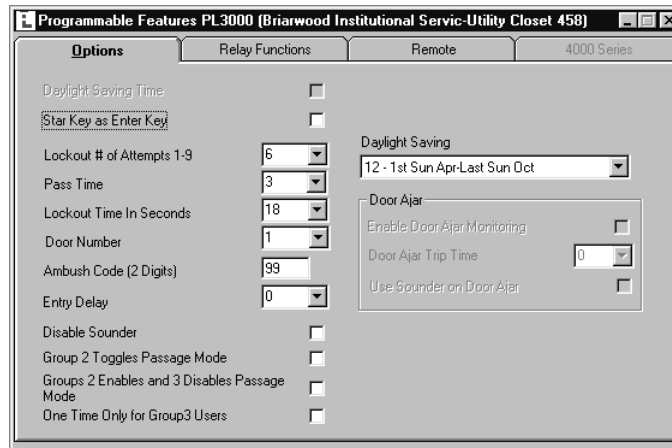

Screen shown is from a PL3000 lock. Screen for DL/PDL series is similar (though some selections may be grayed-out and therefore not available).

Daylight Saving Time

DL3000 Lock Only. The lock will adjust for USA Daylight Saving Time in the spring and the autumn.

Star Key as Enter Key

If checked, all codes entered must be followed by the [*] key.

Lockout # of Attempts 1-9

The maximum number of invalid entry attempts (with wrong User Code) the lock will allow before it goes into lockout mode (where it will refuse to recognize ANY User Code entry). The lock will shut down for the period programmed in the **Lockout Time in Seconds** field which follows. Valid Attempt entries are 1-9.

Pass Time

The duration in seconds that the lock will remain unlocked after a valid code has been entered (valid entries are 3, 10 & 15 seconds).

Lockout Time In Seconds

The duration of time the lock refuses to recognize ANY User Codes after the maximum number of invalid entry attempts (with wrong User Code) has been reached (valid entries are 1-60 seconds).

Door Number

Door Number must be between 1-96*.

If the lock is a new lock without a designated door number, the door number specified in this field will be assigned to the programmed lock. If used with the AL-DTM Data Transfer Module, this is the Door Number the AL-DTM will use to identify itself to the lock, insuring that the proper data inside the AL-DTM2 will be matched to the correct lock.

*Only available numbers are listed. AL-DTM only supports first 48 locks. See page 18 and 21 for more information.

Ambush Code (2 Digits)

A 2 digit code which will activate the auxiliary relay if entered before a valid User Code. You must also select **Ambush** from the Relay Function List.

Entry Delay

Delays door entry after valid User code is entered. **Note:** For DL3500 and PDL3000, valid entries are 0, 5, 15 & 45 seconds.

Disable Sounder

Disable Lock Sounder to enable silent operation.

Group 2 Toggles Passage Mode

A Group 2 User will toggle passage mode (lock is unlocked). **Caution! The consequences of accidentally selecting this option can cause a security breach!**

Groups 2 Enables and 3 Disables Passage Mode

A Group 2 User will put door into passage mode (lock is unlocked). A Group 3 User will take door out of passage. **Caution! The consequences of accidentally selecting this option can cause a security breach!**

One Time Only for Group3 Users

If checked, allows Group 3 Users to unlock the door one time only, then their User Code or proximity card becomes disabled.

Daylight Saving

Daylight Saving Time configuration settings for DL3500 and PDL Series Locks.

Door Ajar
 Enable Door Ajar Monitoring
 Door Ajar Trip Time
 Use Sounder on Door Ajar

For use with the DL/PDL3300 lock. Check **Enable Door Ajar Monitoring** to enable this feature. Select the door ajar delay time (in seconds) from the drop-down list, and check **Use Sounder on Door Ajar** to enable an audible warning upon a valid door ajar trip.

Glossary

ACCESS = Entry into a restricted area.

AMBUSH = A special Code entered at the keypad when the User is forced to unlock a device. The device unlocks but sends a silent alarm with no indication at the keypad. Can be used to trip a relay, to alert security, or trip a silent alarm on a Burglary Control Panel.

AUDIT TRAIL = A date/time stamped log of previous lock events.

BURGLARY CONTROL PANEL = Provides local alarm and remote communication to request security for burglary/break-in. A relay output used for Ambush can provide a silent alarm and call-for-help.

CLOCK

- **REAL TIME CLOCK** = An accurate built-in clock that allows date/time stamping of events. The clock can be slowed or speeded up to fine tune long term accuracy to within three minutes per year.
- **CLOCK SETTINGS** = Printout includes date, time, weekday, and clock speed.
- **CLOCK SPEED** = The clock can be adjusted to allow faster/slower speeds and therefore increasing clock accuracy.

CODE = Numeric sequence of numbers (such as: 1234) entered at the keypad. If Star-Enter-Key is required, must be followed by a  key.

- **AMBUSH CODE** = See Ambush.
- **BASIC USER CODE** = User Codes assigned to User Numbers 12+ (except Users 297-300). (Does not allow programming)
- **INSTALLER CODE** = User Codes assigned to User Numbers 2 and 3. (Allows all programming except Master functions).
- **INVALID CODE** = A User Code that has not been programmed in the lock.
- **MANAGER CODE** = User Codes assigned to User Numbers 4 through 6. (Allows most of the programming functions).
- **MASTER CODE** = User Code assigned to User Number 1. Default (factory) Master Code is 123456. The User with the Master Code has complete control of the lock.
- **PRINT ONLY USER CODE** = User Code assigned to Users 10 and 11. (Allows no programming except print functions).
- **QUICK ENABLE USER 300 CODE** = Refers to the User Code entered by User 297 which (when entered at the keypad) enables the User Code assigned to User 300 for one time only.
- **QUICK PC ACCESS CODE** = Permits upload/download to DL-Windows Software on IBM/compatible computer running Microsoft Windows 95, 98, or NT 4.0. Refers to the User Code for User 298.
- **SERVICE CODE** = User 300 User Code. Allows only one entry, then needs to be re-enabled by the User 297 User Code to regain access.
- **SUPERVISOR CODE** = User Codes assigned to Users 7, 8 and 9. Can only program day-to-day operation.
- **USER CODE** = Code used by Users. Code is 3 to 6 numeric digits long, allowing controlled entry.
- **VALID CODE** = An entered User Code that has been programmed in the device.

COM PORT = A computer serial communications port used to communicate with the Lock and/or Data Transfer Module.

DATA TRANSFER MODULE = A device that permits transfer of program/data between a computer and the lock.

DATE = Month, Day and Year entered as MMDDYY.

DAY OF WEEK = Sunday through Saturday (where 1 = Sunday and 7 = Saturday).

DEFAULT = Default settings are the original settings that were set at the factory; in other words, it is the lock's original factory condition when the lock was first taken out of its box. The default settings are permanently encoded within the lock's fixed memory, and when the lock is first started, or when power is removed and re-applied, the original factory default settings are re-loaded and take effect.

DISABLE = Turn off.

DOOR AJAR = (Used with the PDL3300 lock only). If access is granted with the PDL3300 lock, and the door is held open beyond the pre-programmed amount of time (default is 20 seconds), the lock will trip a 'Door Ajar' event. If programmed, the lock will provide audible annunciation and/or an auxiliary relay closure.

DOOR NUMBER = Identification of each door with a specific number (1-2000). (Used with the AL-DTM and AL-DTM-II. For the AL-DTM-III, see glossary entry "LockID").

DOWNLOAD = Send data to lock or AL-DTM.

ENABLE = Turn on.

EVENTS = Recorded lock activity.

FUNCTION (also called **Programming Functions**) = are the numbers used to program lock features (enabling/disabling Users, User Groups, Passage Mode, Schedules, etc.).

FUNCTION CARDS (Used with the PL3000 lock only) = Nine standard proximity cards labeled one through nine, enrolled into the PL3000 lock. Each card can perform a specific function, such as initiating PC communications or enrolling proximity cards. See WI1280 for more information.

GROUP

- **USER GROUP** = Defining a User to specific Groups, allows User entry when the Group is allowed entry.
- **GROUP 1 DISARMS BURGLAR CONTROL** = A Group 1 USER CODE entry can disarm an alarm panel during a predefined schedule. Should the Group 1 enter the lock outside of the scheduled time, the alarm will not disarm. The alarm panel must be armed through other means (such as an Alarm Panel Keypad). The Burglary Alarm Panel must be programmed to disarm from an Armed State Only and the zone input must be programmed for input disarming.
- **GROUP 1 ENABLES GROUP 4 USERS** = A Group 1 USER CODE entry during a predefined schedule will allow access to Group 4 Users.
- **GROUP 1 PUTS UNIT IN PASSAGE** = A Group 1 USER CODE entry during a pre-defined schedule will unlock unit.

INSTALLER = See... CODE, INSTALLER CODE.

KEYPAD = 10-numeric keys,  and special  key.

- **KEYPAD LOCKOUT** = Keypad is programmed to lockout Users, for a specified period of time, when a specified number of invalid User Codes are entered.
- **KEYPAD PROGRAMMING** = Ability to program the lock through the keypad.

Glossary (cont'd)

KEYPRESS =

Pressing a button on the Lock's Keypad.

LEVEL ABILITY = Predefined User Types (such as Master, Installer, Manager, Supervisor, and Print Only User) have specific abilities to program and/or control the lock.

"LOCKID" = Identification of each door with a specific number--or in other words, a number representing an individual lock within an Account. No longer entered through AL-59. For use with the AL-DTM-III (for the AL-DTM or the AM-DTM-III, see glossary entry "Door Number").

The new LockID format was developed to increase the number of locks allowed per Account (now up to 2000 locks). As a result of this increase, the ability to change the Door Number (now called LockID) at the lock keypad is no longer used. DL-Windows (versions 3.5.3 and greater) software must now be used to change the LockID. When DL-Windows version 3.5+ data is sent to the lock, this LockID is updated.

If you wish to receive data from the lock *before* data is sent, the new **"Update LockID"** option in DL-Windows version 3.5+ will change or update the LockID. In addition, the current keypad *Function 59* (in Programming Mode) is no longer allowed, and is consequently ignored by the DL-Windows software.

LOCKOUT ATTEMPTS = A specified number of invalid User Code entries (1-9), that will disable the keypad for a predefined period of time (1-60 seconds).

LOCKOUT TIME = A predefined time (1-60) seconds that the lock will stop accepting User Codes, after a specified number of invalid User Code entries (1-9).

LOG = See... AUDIT TRAIL.

MANAGER = See... CODE, MANAGER CODE.

MASTER = See... CODE, MASTER CODE.

PASSAGE = Allow anyone to pass through the door without USER CODES (door is unlocked).

PRINTER = A printout device such as an infrared printer or computer printer.

PRIVACY MODE (Factory Default for 4100 Series Locks):

"Privacy Mode" is designed to allow access to individuals with access codes (or PROX cards) and is typically used for rooms needing privacy from others such as bathrooms, dorms and meeting rooms.

PROGRAM MODE = A mode allowing program/data to be entered through the keypad. Only specific Users can program a lock manually, by entering their USER CODE, followed by the  key. To exit program mode, hold any key until repeated beeps are heard.

PROGRAMMABLE RELAY FUNCTIONS = The relay can be programmed for one or more functions.

PROXIMITY CARDS = HID ProxCards® and ProxKey® keyfobs are access control cards manufactured in a variety of bit formats.

Note: ProxCards® and ProxKey® are trademarks of the HID® Corporation.

RELAY = Switched output allowing remote control of other devices. External power source is required.

- **Relay, Ambush Activated** - Ambush Code entered prior to a User Code will trip a relay. This can alert Security or trip a zone on an Alarm Panel.
- **Relay, Any Keypress** - First keypress of any sequence.
- **Relay, Authorized Entry** - Valid User Code entered.
- **Relay, Disabled User Entered Code** - Valid User Code entered but the User is disabled.
- **Relay, Failed Entry Attempt** - Invalid User Code entered.
- **Relay, Keypad Lockout** - Should several Invalid User Codes be entered that exceed the number of lockout attempts (1-9), then the lock will stop accepting keypad entries for the Lockout Time (1-60 seconds). The Relay output can be used to indicate tampering of the keypad.
- **Relay, Group 1 Activation** - A Group 1 User can enter a User Code and can disarm a Burglary Alarm Panel using the Relay Output.

REMOTE INPUT = Entry into a restricted area, by pressing a button connected to the REMOTE INPUT WIRES (White and White) by someone on the other side of the door.

RESIDENCY MODE (Factory Default for 4500 Series Locks):

The "Residency Feature" is provided to prevent a person from unintentionally having the door lock behind them when stepping outside briefly. Typically used in retirement homes and college dormitories.

SCHEDULE = A programmed operation (enable/disable, lock/unlock, etc.) on a specific day (Sunday through Saturday) and time.

SCHEDULES, QUICK = Any one of four most common types of schedules can be programmed.

TIME = Hours and Minutes in the HHMM format.

TIME/DATE STAMP = A recorded date and time that an event occurred.

TIMEOUT = Immediate operation for a specified number of hours.

UPLOAD = Receive data from the lock or AL-DTM.

USER = A person who has been provided with a USER CODE for access through the door.

USER LOCKOUT, TOTAL = All Users (except for Master Code) have been locked out.

Trilogy® is a registered trademark of Alarm Lock.

HID and Microsoft Windows are trademarks of their respective companies.

ALARM LOCK LIMITED WARRANTY

ALARM LOCK SYSTEMS, INC. (ALARM LOCK) warrants its products to be free from manufacturing defects in materials and workmanship for 24 months following the date of manufacture. ALARM LOCK will, within said period, at its option, repair or replace any product failing to operate correctly without charge to the original purchaser or user.

This warranty shall not apply to any equipment, or any part thereof, which has been repaired by others, improperly installed, improperly used, abused, altered, damaged, subjected to acts of God, or on which any serial numbers have been altered, defaced or removed. Seller will not be responsible for any dismantling or reinstallation charges.

THERE ARE NO WARRANTIES, EXPRESS OR IMPLIED, WHICH EXTEND BEYOND THE DESCRIPTION ON THE FACE HEREOF. THERE IS NO EXPRESS OR IMPLIED WARRANTY OF MERCHANTABILITY OR A WARRANTY OF FITNESS FOR A PARTICULAR PURPOSE. ADDITIONALLY, THIS WARRANTY IS IN LIEU OF ALL OTHER OBLIGATIONS OR LIABILITIES ON THE PART OF ALARM LOCK.

Any action for breach of warranty, including but not limited to any implied warranty of merchantability, must be brought within the six months following the end of the warranty period. IN NO CASE SHALL ALARM LOCK BE LIABLE TO ANYONE FOR ANY CONSEQUENTIAL OR INCIDENTAL DAMAGES FOR BREACH OF THIS OR ANY OTHER WARRANTY, EXPRESS OR IMPLIED, EVEN IF THE LOSS OR DAMAGE IS CAUSED BY THE SELLER'S OWN NEGLIGENCE OR FAULT.

In case of defect, contact the security professional who installed and maintains your security system. In order to exercise the warranty, the product must be returned by the security professional, shipping costs prepaid and insured to ALARM LOCK. After repair or replacement, ALARM LOCK assumes the cost of returning products under warranty. ALARM LOCK shall have no obligation under this warranty, or otherwise, if the product has been repaired by others, improperly installed, improperly used, abused, altered, damaged, subjected to accident, nuisance, flood, fire or acts of God, or on which any serial numbers have been altered, defaced or removed. ALARM LOCK will not be responsible for any dismantling, reassembly or reinstallation charges.

This warranty contains the entire warranty. It is the sole warranty and any prior agreements or representations, whether oral or written, are either merged herein or are expressly cancelled. ALARM LOCK neither assumes, nor authorizes any other person purporting to act on its behalf

to modify, to change, or to assume for it, any other warranty or liability concerning its products.

In no event shall ALARM LOCK be liable for an amount in excess of ALARM LOCK's original selling price of the product, for any loss or damage, whether direct, indirect, incidental, consequential, or otherwise arising out of any failure of the product. Seller's warranty, as hereinabove set forth, shall not be enlarged, diminished or affected by and no obligation or liability shall arise or grow out of Seller's rendering of technical advice or service in connection with Buyer's order of the goods furnished hereunder.

ALARM LOCK RECOMMENDS THAT THE ENTIRE SYSTEM BE COMPLETELY TESTED WEEKLY.

Warning: Despite frequent testing, and due to, but not limited to, any or all of the following; criminal tampering, electrical or communications disruption, it is possible for the system to fail to perform as expected. ALARM LOCK does not represent that the product/system may not be compromised or circumvented; or that the product or system will prevent any personal injury or property loss by burglary, robbery, fire or otherwise; nor that the product or system will in all cases provide adequate warning or protection. A properly installed and maintained alarm may only reduce risk of burglary, robbery, fire or otherwise but it is not insurance or a guarantee that these events will not occur. CONSEQUENTLY, SELLER SHALL HAVE NO LIABILITY FOR ANY PERSONAL INJURY, PROPERTY DAMAGE, OR OTHER LOSS BASED ON A CLAIM THE PRODUCT FAILED TO GIVE WARNING. Therefore, the installer should in turn advise the consumer to take any and all precautions for his or her safety including, but not limited to, fleeing the premises and calling police or fire department, in order to mitigate the possibilities of harm and/or damage.

ALARM LOCK is not an insurer of either the property or safety of the user's family or employees, and limits its liability for any loss or damage including incidental or consequential damages to ALARM LOCK's original selling price of the product regardless of the cause of such loss or damage.

Some states do not allow limitations on how long an implied warranty lasts or do not allow the exclusion or limitation of incidental or consequential damages, or differentiate in their treatment of limitations of liability for ordinary or gross negligence, so the above limitations or exclusions may not apply to you. This Warranty gives you specific legal rights and you may also have other rights which vary from state to state.